

**VELUX®**

# DML/RML

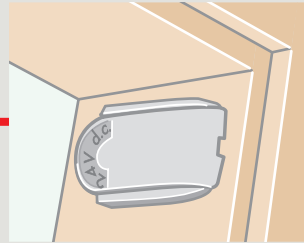

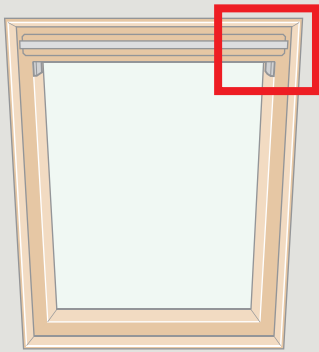

**PAGES  
4-15**

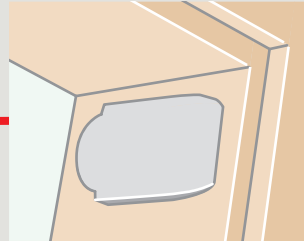

**PAGES  
16-31**

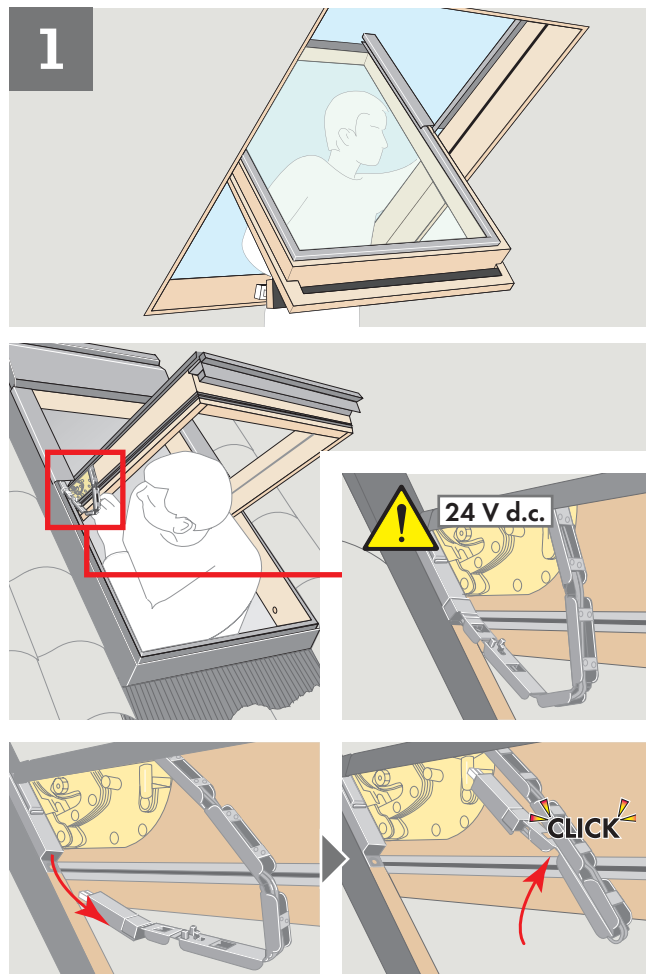
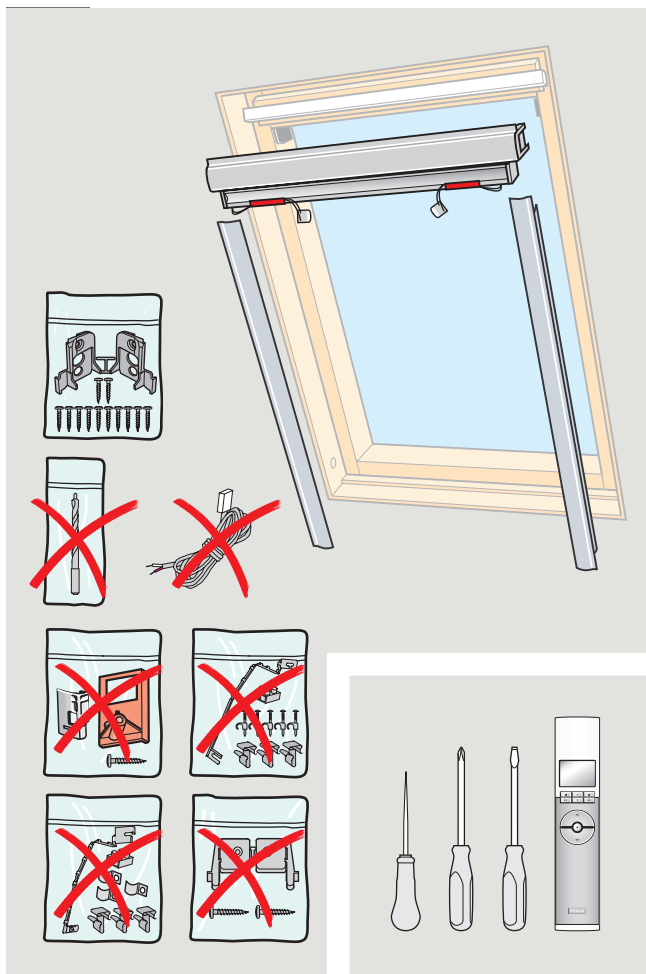

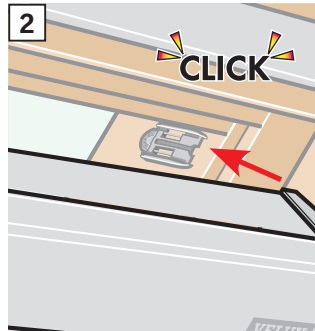
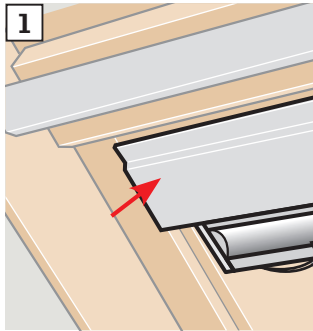
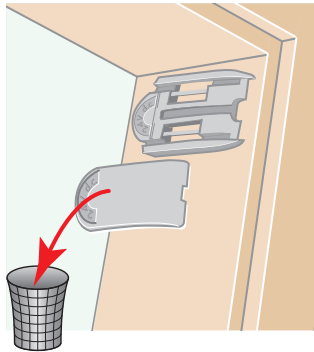
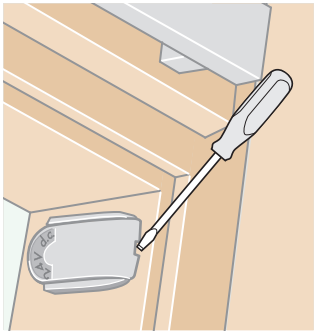
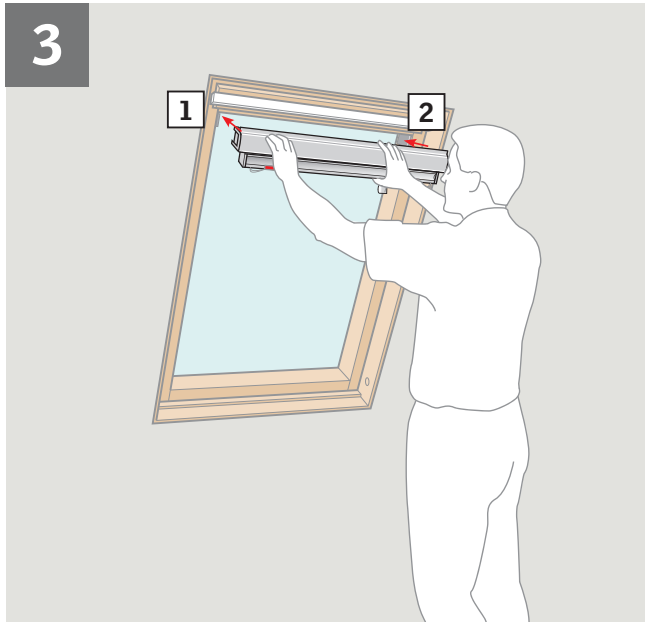
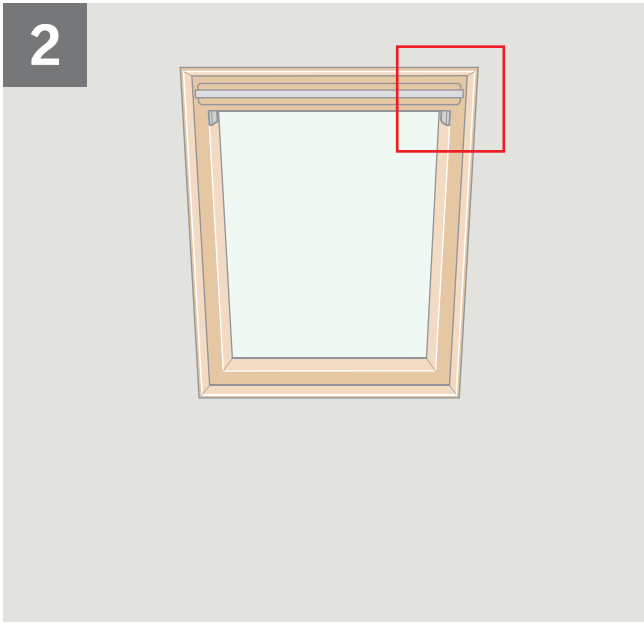

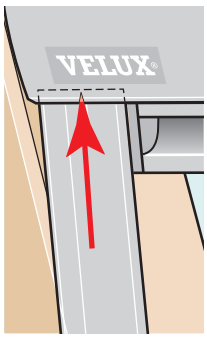
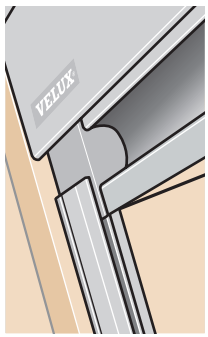
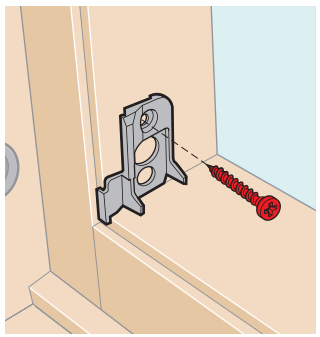
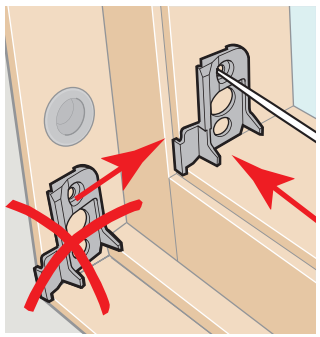
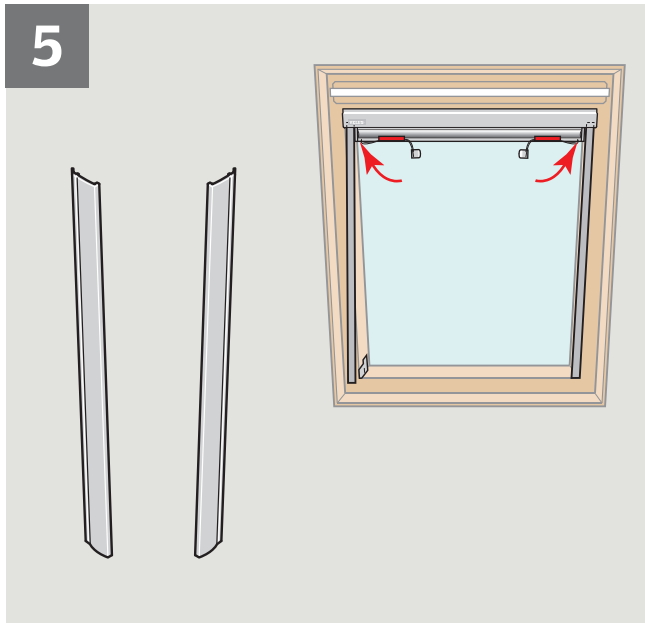
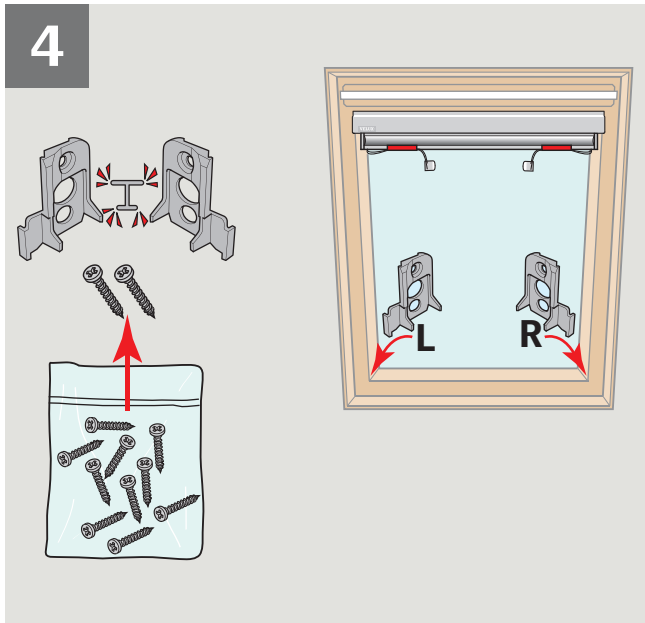

6

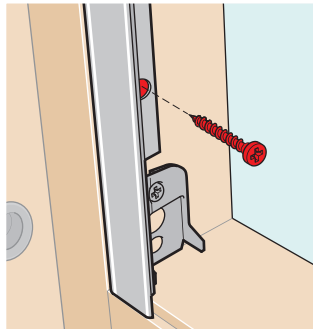
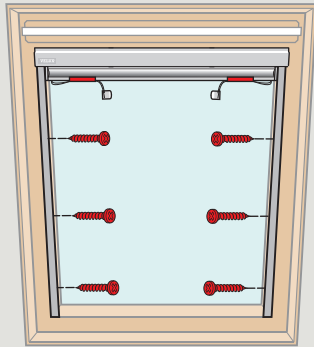
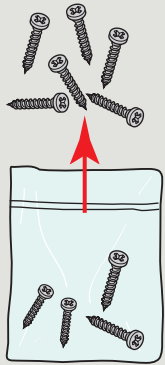

7

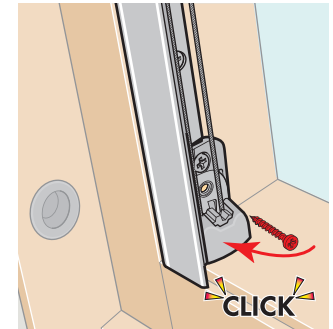
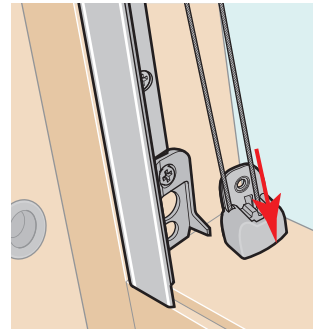
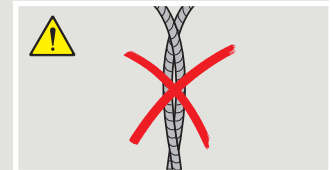
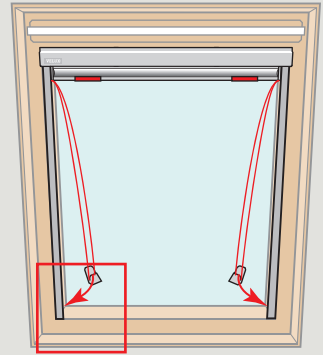
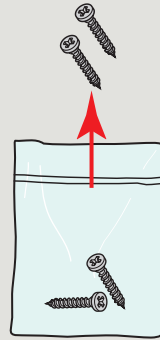

8

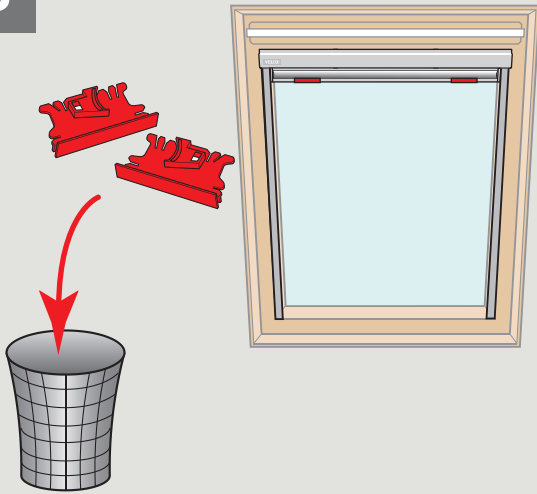

9

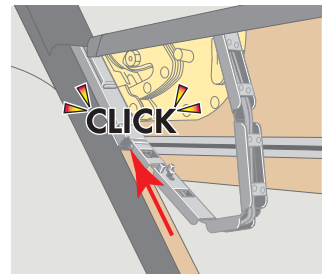
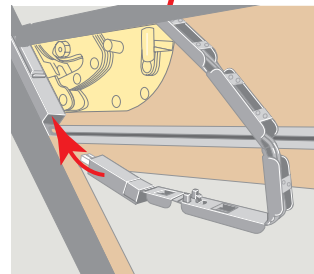
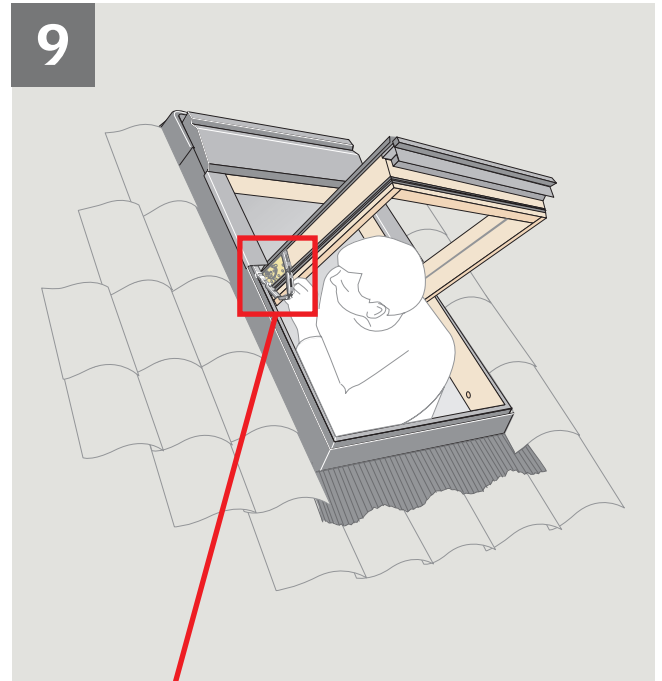

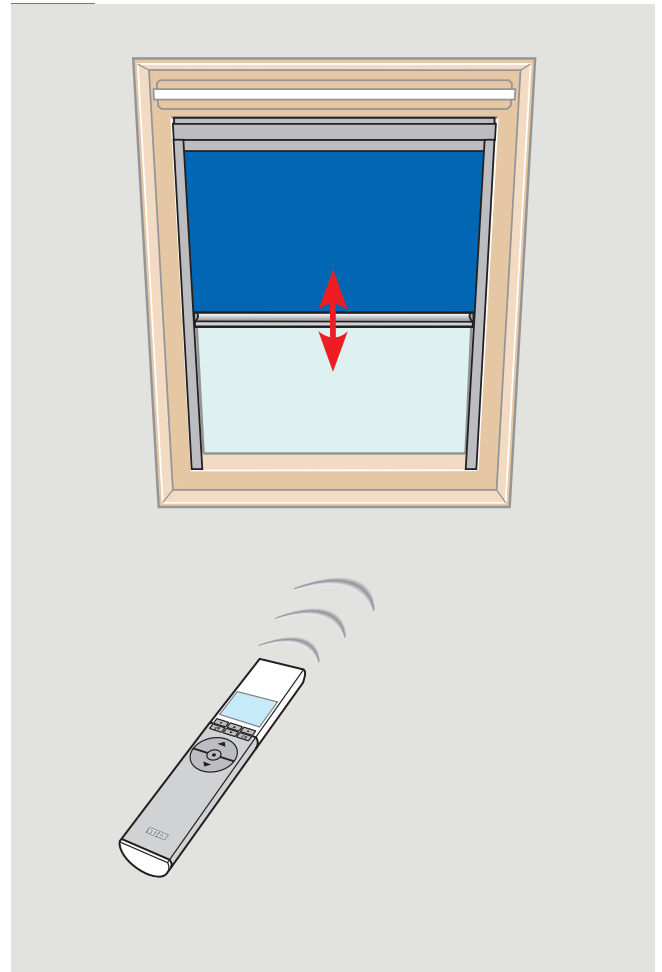
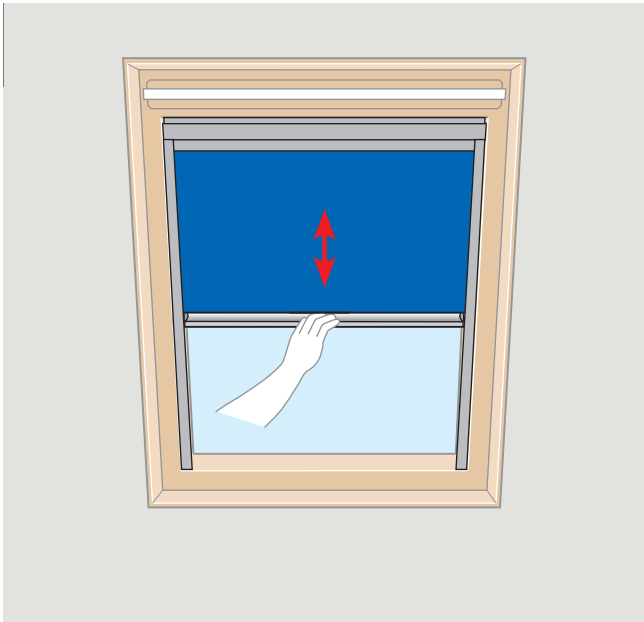



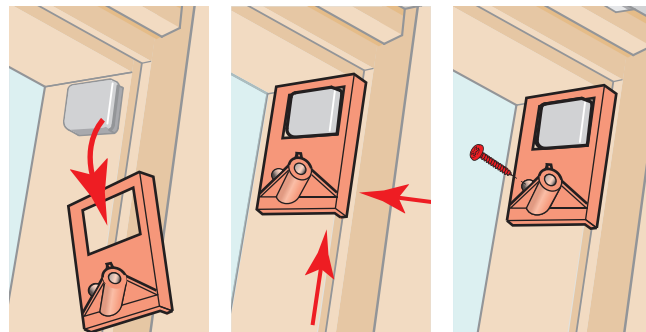
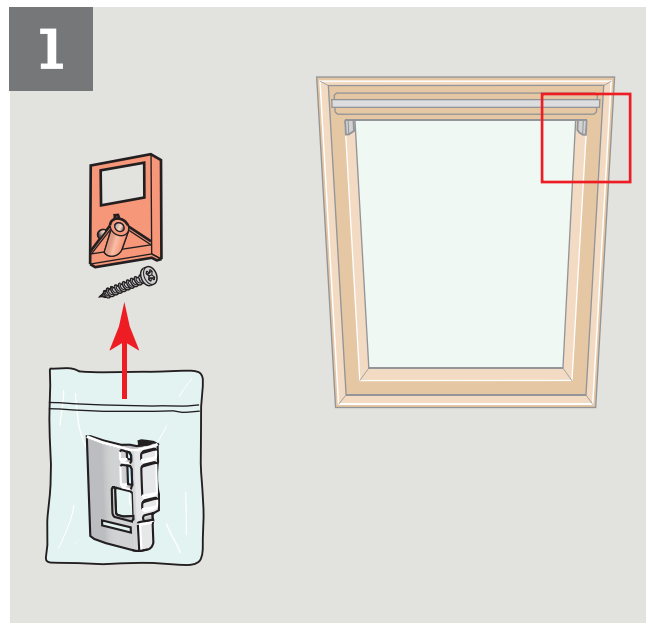
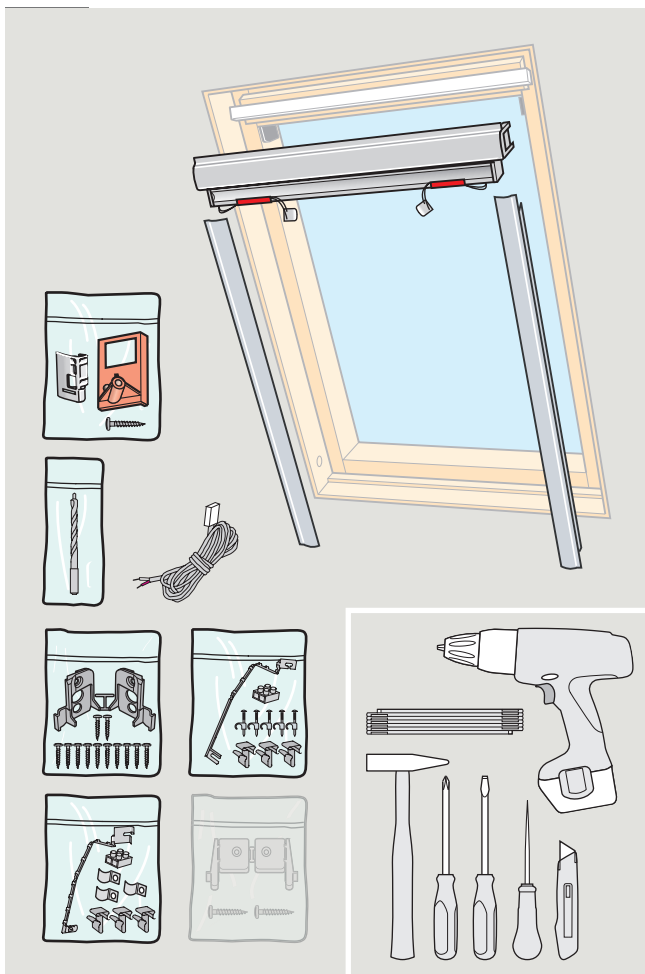

2

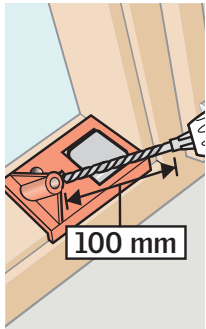
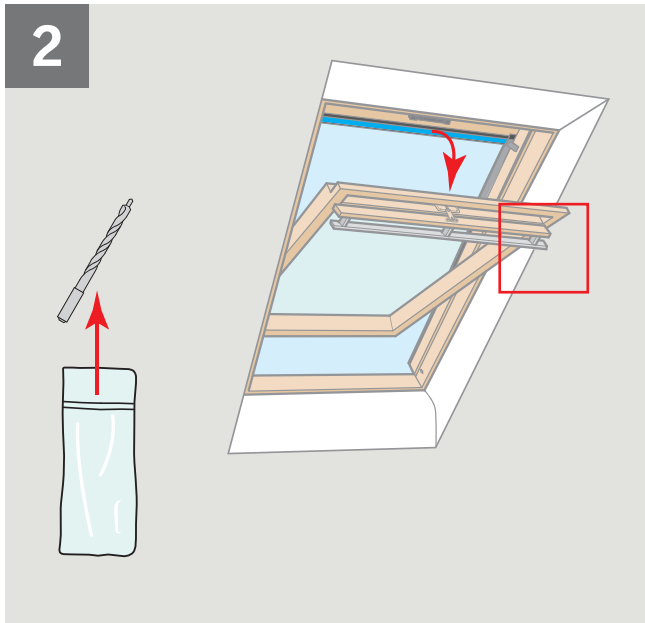

100 mm

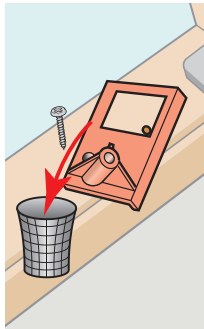
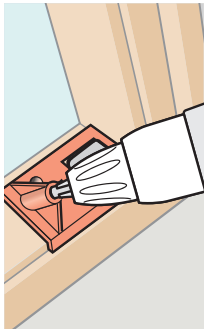

3

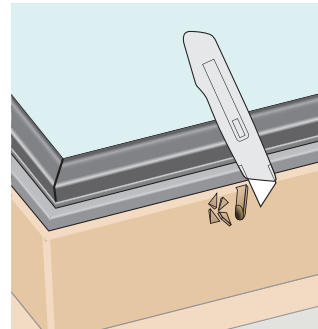
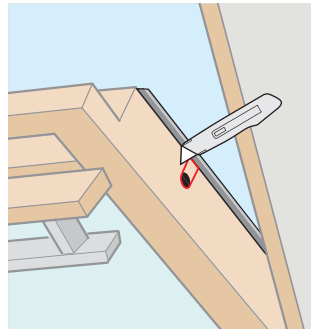
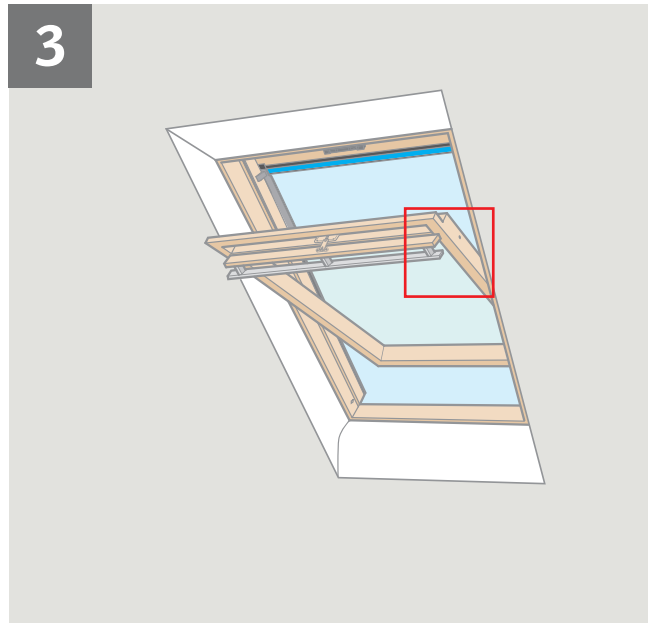

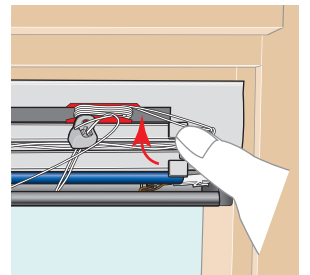
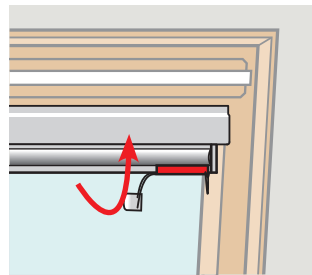
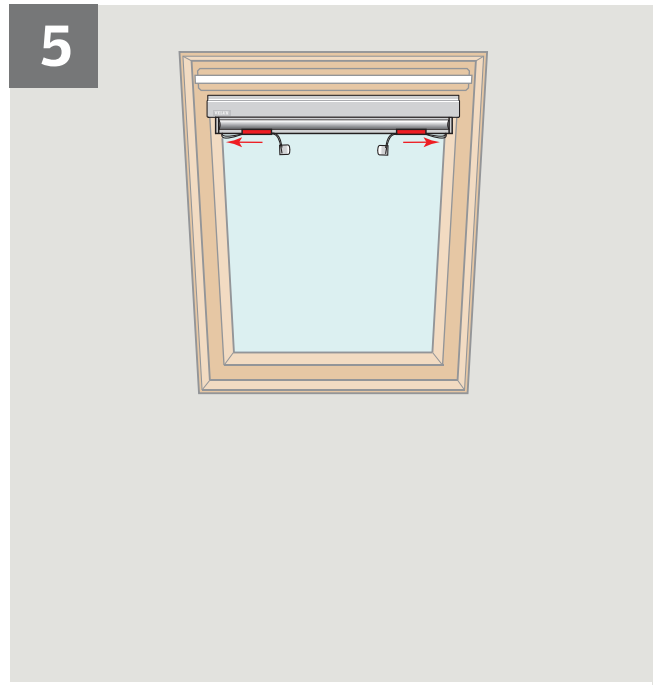
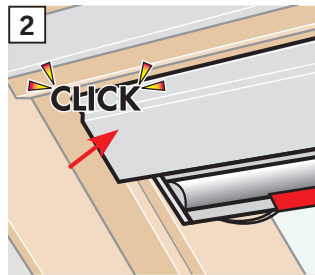
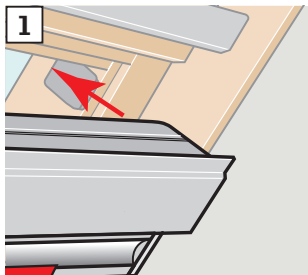
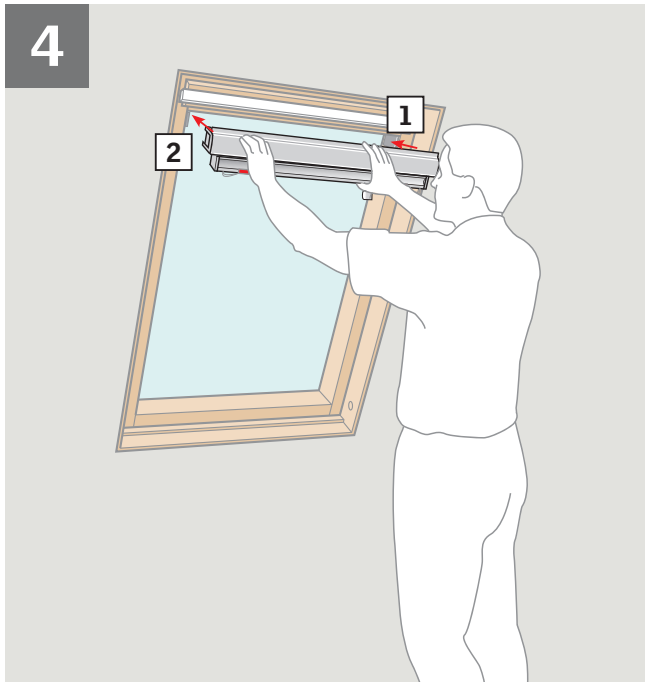

6

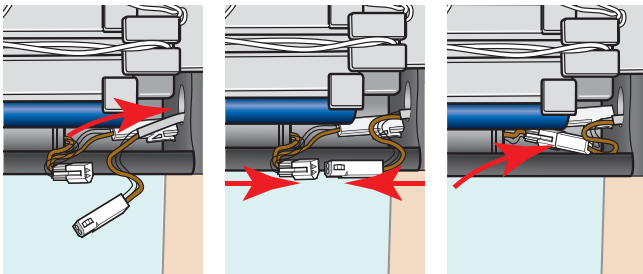
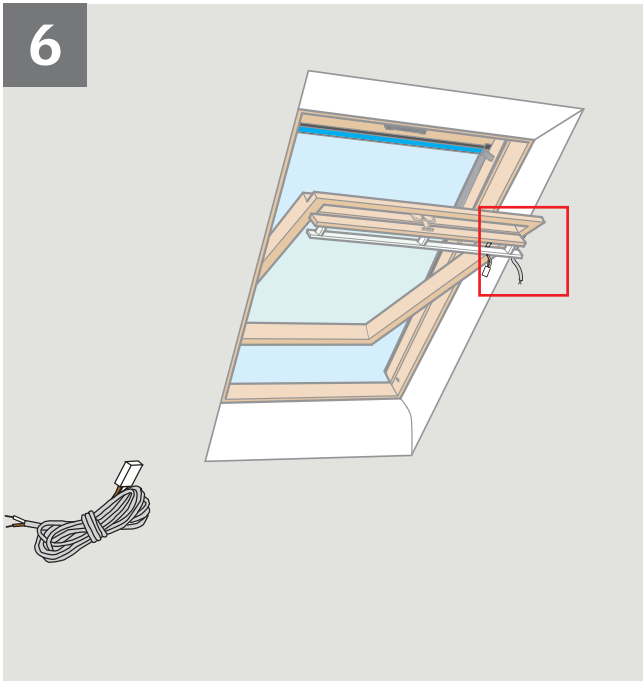

7

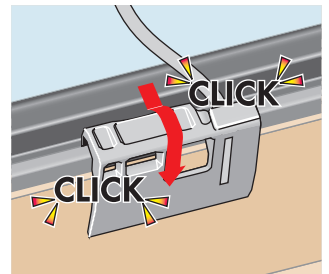
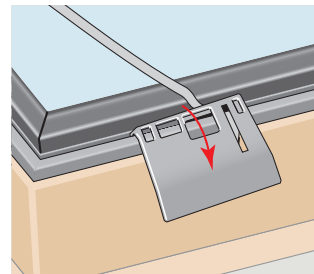
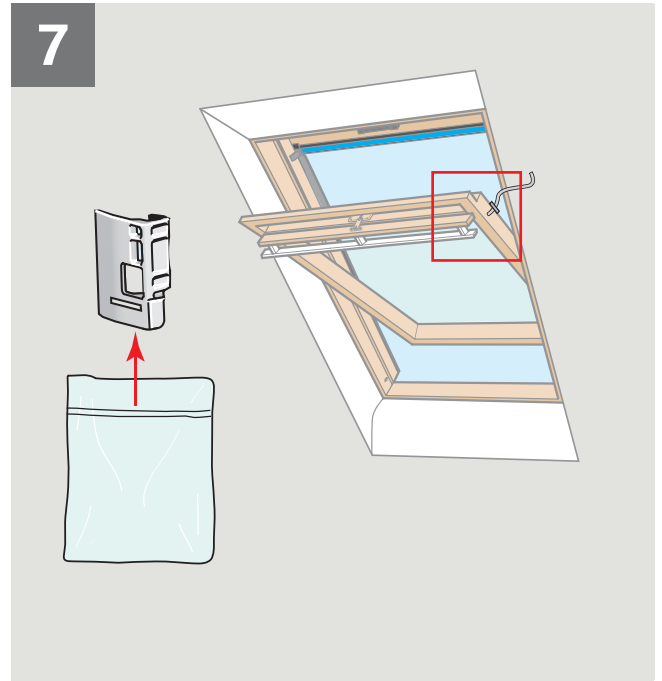

8

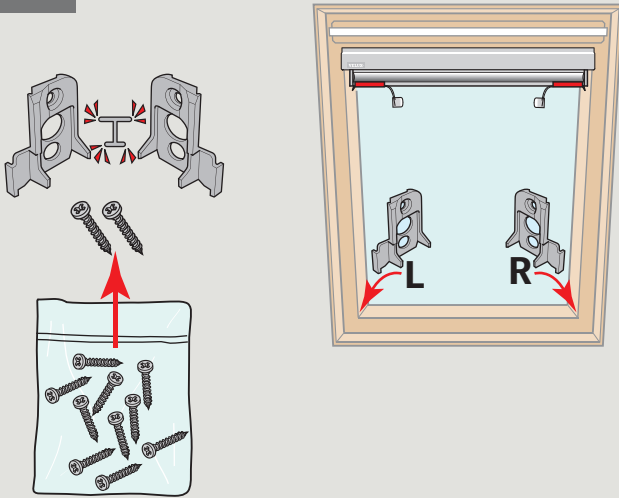

9

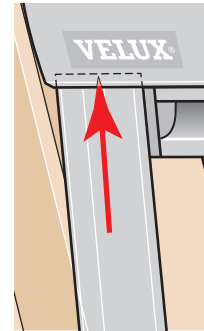
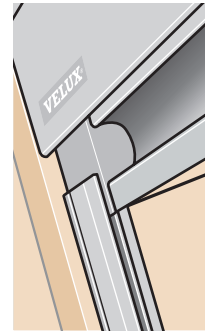
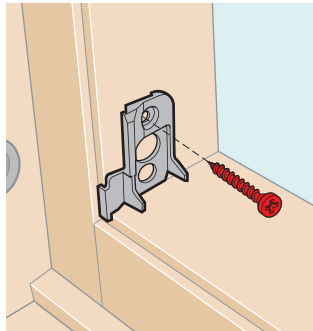
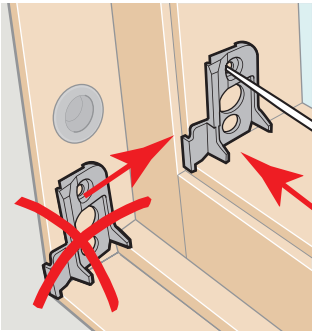
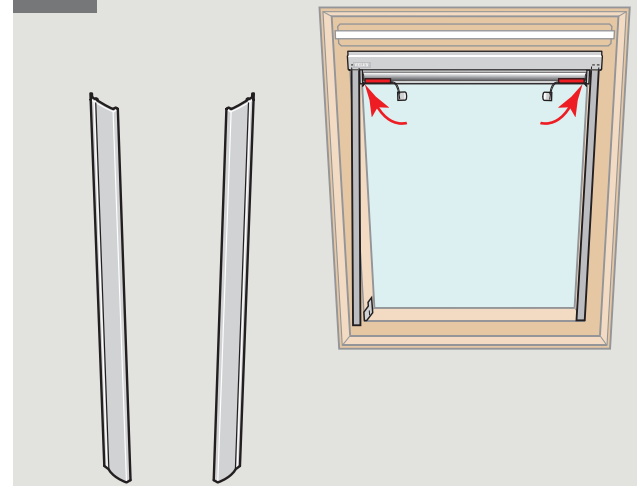

10

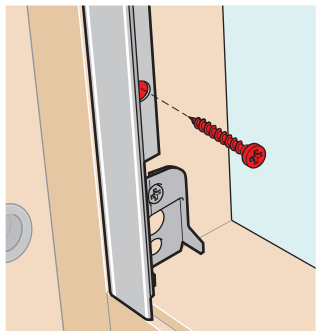
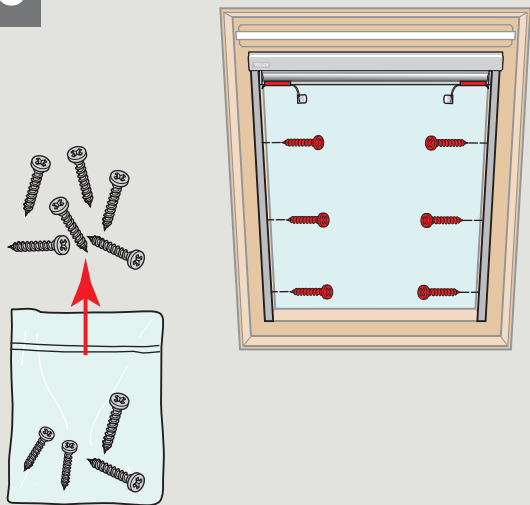

11

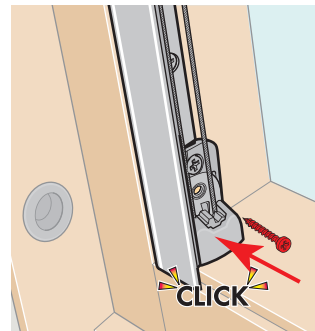
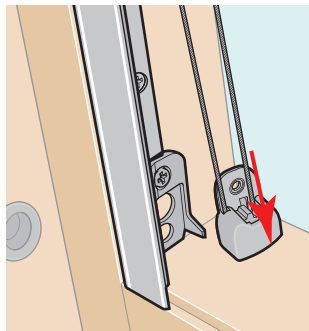
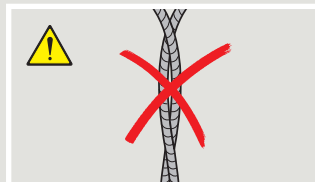
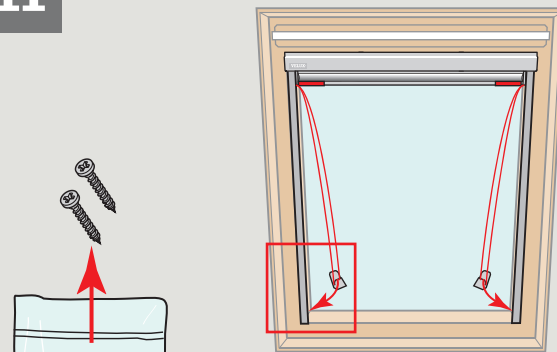

12

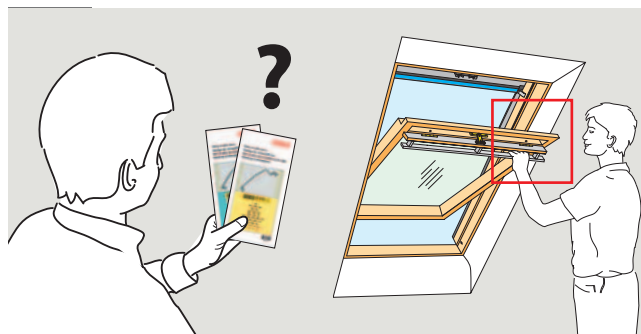
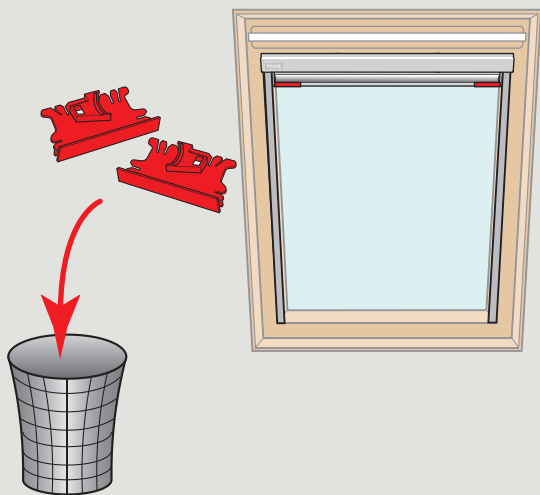

**B04**  
**C01•C02•C04•C06**  
**F04•F06•F08**  
**M04•M06•M08•M10•M12**  
**P25•P04•P06•P08•P10**  
**S01•S06•S08•S10**  
**U04•U08•U10**  
**X99**

**064**  
**101•102•104**  
**204•206**  
**325•304•306**  
**308•310•312**  
**425•404•406•408•410**  
**601•606•608•610**  
**804•808•810**  
**1•2•3•4•5•6•7•8•9**  
**10•11•13•14•31•999**

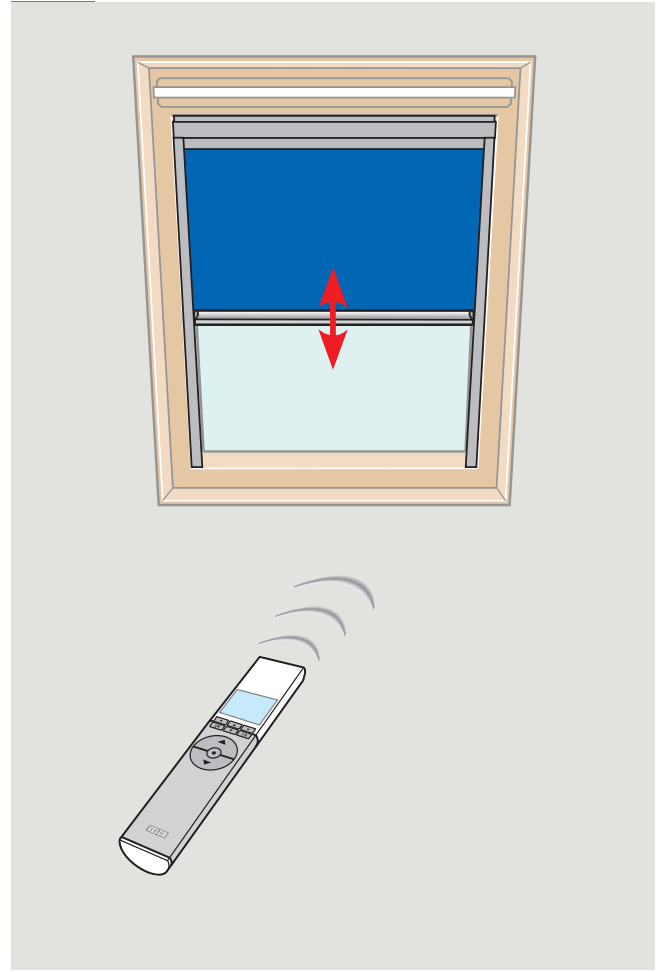
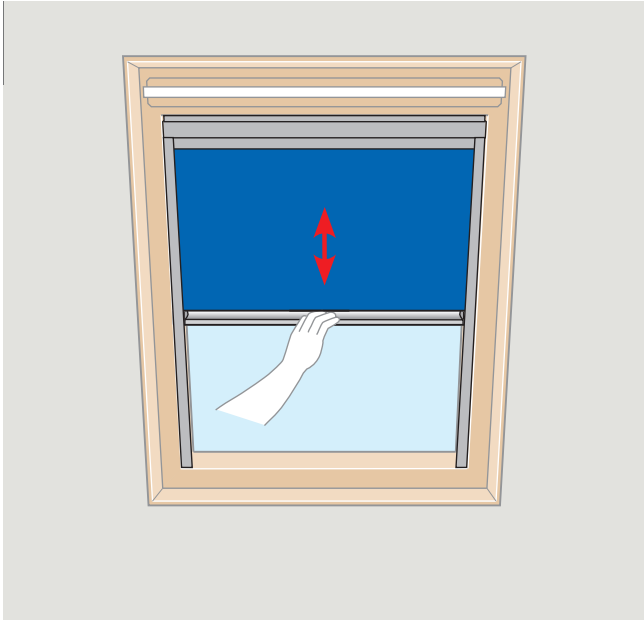



# VELUX®

<b>AR:</b>	<b>VELUX Argentina S.A.</b> 0 114 711 5666	<b>IE:</b>	<b>VELUX Company Ltd.</b> 01 848 8775
<b>AT:</b>	<b>VELUX Österreich GmbH</b> 02245/32 3 50	<b>IT:</b>	<b>VELUX Italia s.p.a.</b> 045/6173666
<b>AU:</b>	<b>VELUX Australia Pty. Ltd.</b> 1300 859 856	<b>JP:</b>	<b>VELUX-Japan Ltd.</b> 0570-00-8145
<b>BA:</b>	<b>VELUX Bosna i Hercegovina d.o.o.</b> 033/626 493, 626 494	<b>LT:</b>	<b>VELUX Lietuva, UAB</b> (85) 270 91 01
<b>BE:</b>	<b>VELUX Belgium</b> (010) 42.09.09	<b>LV:</b>	<b>VELUX Latvia SIA</b> 67 27 77 33
<b>BG:</b>	<b>VELUX Bulgaria EOOD</b> 02/955 95 26	<b>NL:</b>	<b>VELUX Nederland B.V.</b> 030 - 6 629 629
<b>BY:</b>	<b>VELUX Roof Windows FE</b> (017) 217 7385	<b>NO:</b>	<b>VELUX Norge AS</b> 22 51 06 00
<b>CA:</b>	<b>VELUX Canada Inc.</b> 1 800 88-VELUX (888-3589)	<b>NZ:</b>	<b>VELUX New Zealand Ltd.</b> 0800 650 445
<b>CH:</b>	<b>VELUX Schweiz AG</b> 0848 945 549	<b>PL:</b>	<b>VELUX Polska Sp. z o.o.</b> (022) 33 77 000 / 33 77 070
<b>CL:</b>	<b>VELUX Chile Limitada</b> 2 953 6789	<b>PT:</b>	<b>VELUX Portugal, Lda</b> 21 880 00 60
<b>CN:</b>	<b>VELUX (CHINA) CO. LTD.</b> 0316-607 27 27	<b>RO:</b>	<b>VELUX România S.R.L.</b> 0-8008-83589
<b>CZ:</b>	<b>VELUX Česká republika, s.r.o.</b> 531 015 511	<b>RS:</b>	<b>VELUX Srbija d.o.o.</b> 011 3670 468
<b>DE:</b>	<b>VELUX Deutschland GmbH</b> 0180-333 33 99	<b>RU:</b>	<b>ZAO VELUX</b> (495) 737 75 20
<b>DK:</b>	<b>VELUX Danmark A/S</b> 45 16 45 16	<b>SE:</b>	<b>VELUX Svenska AB</b> 042/20 83 80
<b>EE:</b>	<b>VELUX Eesti OÜ</b> 621 7790	<b>SI:</b>	<b>VELUX Slovenija d.o.o.</b> 01 724 68 68
<b>ES:</b>	<b>VELUX Spain, S.A.</b> 91 509 71 00	<b>SK:</b>	<b>VELUX Slovensko, s.r.o.</b> (02) 33 000 555
<b>FI:</b>	<b>VELUX Suomi Oy</b> 0207 290 800	<b>TR:</b>	<b>VELUX Çati Pencereleeri Ticaret Limited Şirketi</b> 0 216 302 54 10
<b>FR:</b>	<b>VELUX France</b> 0821 02 15 15 0,119€ TTC/min	<b>UA:</b>	<b>VELUX Ukraina TOV</b> (044) 2916070
<b>GB:</b>	<b>VELUX Company Ltd.</b> 01592 778 225	<b>US:</b>	<b>VELUX America Inc.</b> 1-800-88-VELUX
<b>HR:</b>	<b>VELUX Hrvatska d.o.o.</b> 01/5555 444		
<b>HU:</b>	<b>VELUX Magyarország Kft.</b> (06/1) 436-0601		

[www.velux.com](http://www.velux.com)