

Approval body for construction products
and types of construction

Bautechnisches Prüfamt

An institution established by the Federal and
Laender Governments



European Technical Assessment

ETA-07/0135
of 9 December 2016

English translation prepared by DIBt - Original version in German language

General Part

Technical Assessment Body issuing the
European Technical Assessment:

Deutsches Institut für Bautechnik

Trade name of the construction product

fischer drop-in anchor EA II

Product family
to which the construction product belongs

Deformation-controlled expansion anchor for use in
non-cracked concrete

Manufacturer

fischerwerke GmbH & Co. KG
Klaus-Fischer-Straße 1
72178 Waldachtal
DEUTSCHLAND

Manufacturing plant

fischerwerke

This European Technical Assessment
contains

15 pages including 3 annexes

This European Technical Assessment is
issued in accordance with Regulation (EU)
No 305/2011, on the basis of

Guideline for European technical approval of "Metal
anchors for use in concrete", ETAG 001 Part 4:
"Deformation controlled expansion anchors", April 2013,
used as European Assessment Document (EAD)
according to Article 66 Paragraph 3 of Regulation (EU)
No 305/2011.

This version replaces

ETA-07/0135 issued on 28 July 2016

The European Technical Assessment is issued by the Technical Assessment Body in its official language. Translations of this European Technical Assessment in other languages shall fully correspond to the original issued document and shall be identified as such.

Communication of this European Technical Assessment, including transmission by electronic means, shall be in full. However, partial reproduction may only be made with the written consent of the issuing Technical Assessment Body. Any partial reproduction shall be identified as such.

This European Technical Assessment may be withdrawn by the issuing Technical Assessment Body, in particular pursuant to information by the Commission in accordance with Article 25(3) of Regulation (EU) No 305/2011.

Specific Part

1 Technical description of the product

The Fischer drop-in anchor EA II is an anchor made of galvanized or stainless steel which is placed into a drilled hole and anchored by deformation-controlled expansion.

The fixture shall be anchored with a fastening screw or threaded rod.

The product description is given in Annex A.

2 Specification of the intended use in accordance with the applicable European Assessment Document

The performances given in Section 3 are only valid if the anchor is used in compliance with the specifications and conditions given in Annex B.

The verifications and assessment methods on which this European Technical Assessment is based lead to the assumption of a working life of the anchor of at least 50 years. The indications given on the working life cannot be interpreted as a guarantee given by the producer, but are to be regarded only as a means for choosing the right products in relation to the expected economically reasonable working life of the works.

3 Performance of the product and references to the methods used for its assessment

3.1 Mechanical resistance and stability (BWR 1)

Essential characteristic	Performance
Characteristic resistance for static and quasi-static loading, displacements	See Annex C 1 to C 4

3.2 Safety in case of fire (BWR 2)

Essential characteristic	Performance
Reaction to fire	Anchorage satisfies requirements for Class A1
Resistance to fire	No performance assessed

3.4 Safety in use (BWR 4)

The essential characteristics regarding Safety in use are included under the Basic Works Requirement Mechanical resistance and stability.

4 Assessment and verification of constancy of performance (AVCP) system applied, with reference to its legal base

In accordance with guideline for European technical approval ETAG 001, April 2013 used as European Assessment Document (EAD) according to Article 66 Paragraph 3 of Regulation (EU) No 305/2011 the applicable European legal act is: [96/582/EC].

The system to be applied is: 1

5 Technical details necessary for the implementation of the AVCP system, as provided for in the applicable EAD

Technical details necessary for the implementation of the AVCP system are laid down in the control plan deposited with Deutsches Institut für Bautechnik.

Issued in Berlin on 9 December 2016 by Deutsches Institut für Bautechnik

Andreas Kummerow
p. p. Head of Department

beglaubigt:
Lange

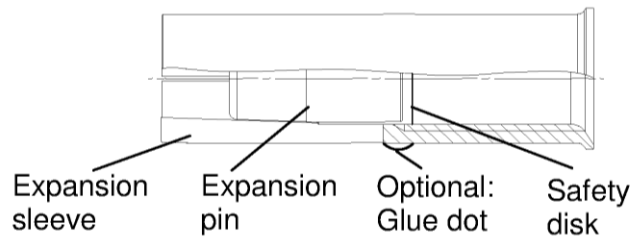
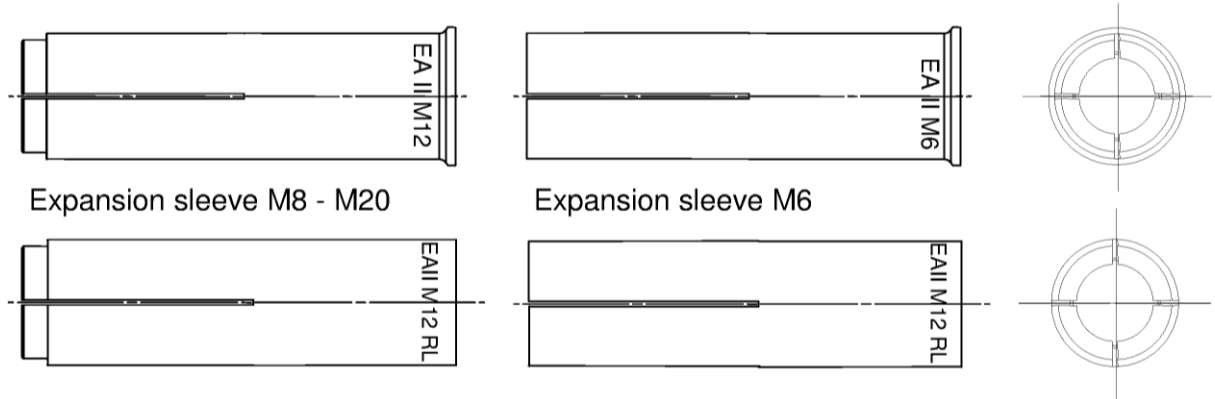

Intended use in concrete

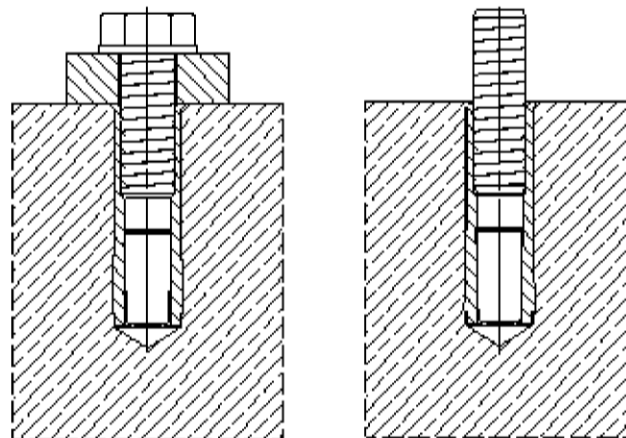

fischer drop-in anchor EA II

Product description
Anchor types
Installed condition

Annex A 1

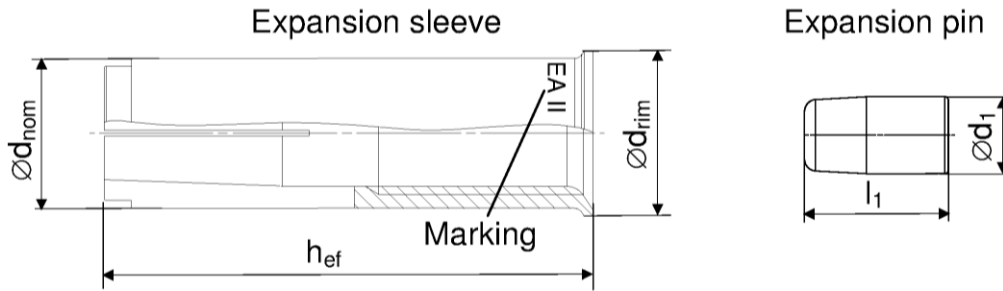

Anchor size EA II	M6x30	M8x30	M8x40	M10x30	M10x40	M12x50	M12x50 D	M16x65	M20x80
h_{ef} [mm]	30	30	40	30	40	50		65	80
$\varnothing d_{nom}$ [mm]	8	10		12		15	16	20	25
$\varnothing d_{rim}$ [mm]	9,5	11,5	13,5		16,5	17,5	21,5	27,0	
$\varnothing d_1$ [mm]	5	6,5	8		10		13,5	17,5	
l_1 [mm]	14	13,5	13	18	18	25	26		

Distinctive feature

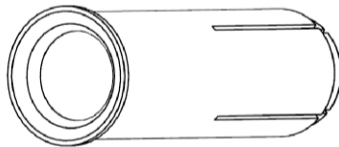

0x groove for:

- EA II M6x30..
- EA II M8x30..
- EA II M10x40..
- EA II M12x50..
- EA II M16x65..
- EA II M20x80..

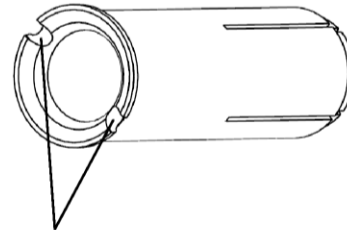

2x groove for:

- EA II M8x40..
- EA II M10x30..

Marking on anchor body

galvanized steel (gvz)		stainless steel (A4)	
with rim	rimless	with rim	rimless
EA II M6x30	EA II M6x30 RL	EA II M6x30 A4	EA II M6x30 RL A4
EA II M8x30	EA II M8x30 RL	EA II M8x30 A4	EA II M8x30 RL A4
EA II M8x40	EA II M8x40 RL	EA II M8x40 A4	EA II M8x40 RL A4
EA II M10x30	EA II M10x30 RL	EA II M10x30 A4	EA II M10x30 RL A4
EA II M10x40	EA II M10x40 RL	EA II M10x40 A4	EA II M10x40 RL A4
EA II M12x50	EA II M12x50 RL	EA II M12x50 A4	EA II M12x50 RL A4
EA II M12x50 D	EA II M12x50 RLD	EA II M12x50 DA4	EA II M12x50 RL DA4
EA II M16x65	EA II M16x65 RL	EA II M16x65 A4	EA II M16x65 RL A4
EA II M20x80	EA II M20x80 RL	EA II M20x80 A4	EA II M20x80 RL A4

fischer drop-in anchor EA II

Product description
Anchor types

Annex A 2

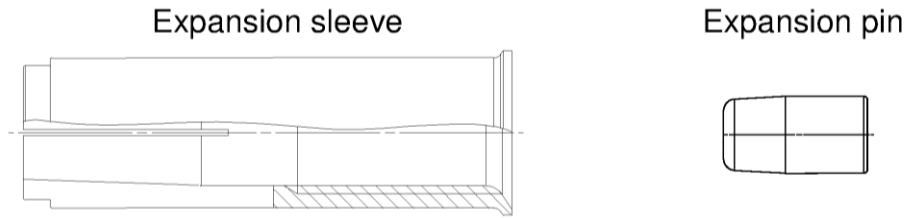

Table A1: Materials

Designation	Material	
	galvanised steel ($\geq 5 \mu\text{m}$)	stainless steel
Expansion sleeve	EN 10277:2008 or EN 10084:2008 or EN 10111:2008 or EN 10263:2001 or EN 10087:1998 or ASTM A29/A29M	EN 10088:2005
Expansion pin		
Fastening screw or threaded rod	steel, property class 4.6, 5.6, 5.8 or 8.8 according to EN ISO 898-1:2012	property class 50, 70 or 80 according to EN ISO 3506:2009

Intended use

Anchorage subject to:

- Static and quasi-static loads

Base materials:

- Reinforced or unreinforced normal weight concrete according to EN 206-1:2000
- Strength classes C20/25 to C50/60 according to EN 206-1:2000
- Non-cracked concrete: all sizes

Use conditions (Environmental conditions):

- Structures subject to dry internal conditions (zinc coated steel or stainless steel)
- Structures subject to external atmospheric exposure (including industrial and marine environment) and to permanently damp internal condition, if no particular aggressive conditions exist (stainless steel)

Note: Particular aggressive conditions are e.g. permanent, alternating immersion in seawater or the splash zone of seawater, chloride atmosphere of indoor swimming pools or atmosphere with extreme chemical pollution (e.g. in desulphurization plants or road tunnels where de-icing materials are used)

Design:

- Anchorages are designed under the responsibility of an engineer experienced in anchorages and concrete work
- Verifiable calculation notes and drawings are prepared taking into account the loads to be anchored. The position of the anchor is indicated on the design drawings (e. g. position of the anchor relative to reinforcement or to supports, etc.)
- Anchorages under static or quasi-static actions are to be designed in accordance with:
 - ETAG 001, Annex C, design method A, Edition August 2010 or
 - CEN/TS 1992-4:2009, design method A
- Fasteners can be used as a single fixing for use in structural application, according to: ETAG 001 Part 4, Edition August 2010

Installation:

- Anchor installation carried out by appropriately qualified personnel and under the supervision of the person responsible for technical matters of the site
- Create drill hole with hammer drill or with hollow drill and vacuum cleaner
- The anchor may only be used once
- In case of aborted hole: New hole must be drilled at a minimum distance of twice the depth of the aborted hole or closer, if the hole is filled with a high strength mortar and only if the hole is not in the direction of the oblique tensile or shear load
- Anchor expansion by impact using the setting tools given in Annex B 3. The anchor is properly set if the stop of the setting tool reaches the expansion sleeve. The manual setting tool with installation control leaves a visible mark on the sleeve, as illustrated in Annex B 3 and B 4

fischer drop-in anchor EA II

Intended Use
Specifications

Annex B 1

Table B2: Installation parameters for concrete C20/25 to C50/60

Anchor size			M6x30	M8x30	M8x40	M10x30	M10x40	M12x50	M12x50 D	M16x65	M20x80
Nominal drill hole diameter	d_0	[mm]	8	10		12		15	16	20	25
Effective anchorage depth	h_{ef}	[mm]	30	30	40	30	40	50		65	80
Maximum installation torque	max. T_{inst}	[Nm]	4	8		15		35		60	120
Minimum drill hole depth	h_1	[mm]	32	33	43	33	43	54		70	85
Minimum screw-in depth	$l_{s,min}$	[mm]	6	8		10		12		16	20
Maximum screw-in depth	$l_{s,max}$	[mm]	14	14		14	17	22		28	34
Clearance of hole diameter	$\varnothing d_f \leq$	[mm]	7	9		12		14		18	22
$h_{min} = 80$ mm											
Minimum spacing	S_{min}	[mm]	70	110	200	200		-	-	-	-
Minimum edge distance	C_{min}	[mm]	150	150		150		-	-	-	-
$h_{min} = 100$ mm											
Minimum spacing	S_{min}	[mm]	65	70	90	150	200		-	-	-
Minimum edge distance	C_{min}	[mm]	115	115		160	180	200		-	-
$h_{min} = 120$ mm											
Minimum spacing	S_{min}	[mm]	65	70	85	95	145		-	-	-
Minimum edge distance	C_{min}	[mm]	115	115		140	150	200		-	-
$h_{min} = 160$ mm											
Minimum spacing	S_{min}	[mm]	65	70	85	95	145		180	-	-
Minimum edge distance	C_{min}	[mm]	115	115		140	150	200		240	-
$h_{min} = 200$ mm											
Minimum spacing	S_{min}	[mm]	65	70	85	95	145		180	190	-
Minimum edge distance	C_{min}	[mm]	115	115		140	150	200		240	280

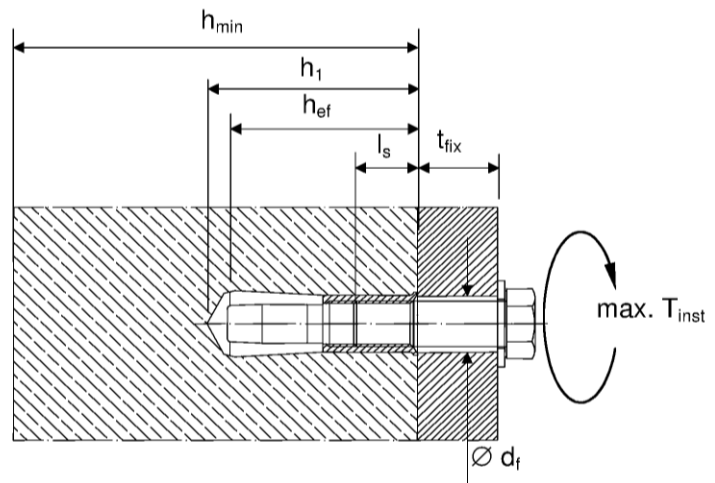
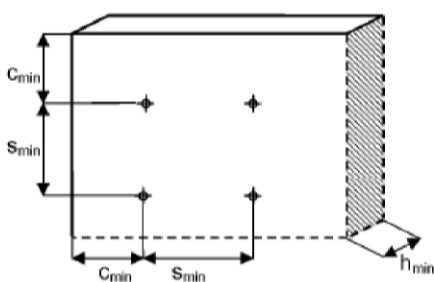

Fastening screw or threaded rod:

- Minimum property class and materials according to table A1
- The length of the fastening screw or threaded rod shall be determined depending on thickness of fixture t_{fix} , admissible tolerances and maximum screw length $l_{s,max}$ as well as minimum screw-in depth $l_{s,min}$



fischer drop-in anchor EA II

Intended Use
Installation parameters

Annex B 2

Setting & drilling tools

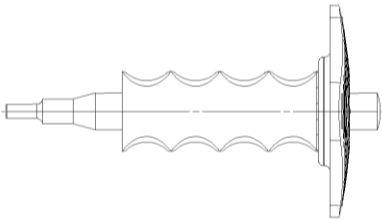
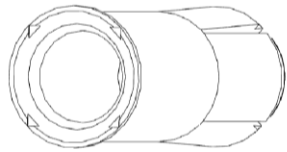
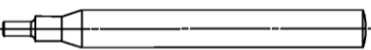
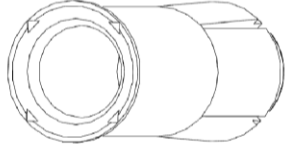
Setting tools

Setting tools	Marking	Description	Marking on EA II with rim and rimless
	EHS Plus M..x h _{ef}	Manual setting tool with hand guard	
	EHS M..x h _{ef}	Manual setting tool basic format	
	EMS M..x h _{ef}	Machine setting tool with SDS Plus	No marking

Drilling tools

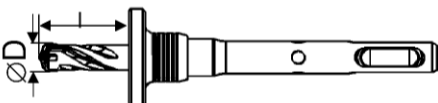
	EBB ØD x l	Stop drill
Or other usual drill		

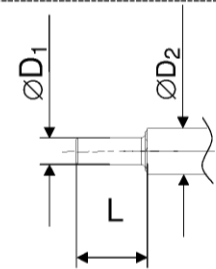

Table B3: Parameters of setting tools

Manual setting tool	Machine setting tool	Stop drill	For anchor size EA II	Ø D1	Ø D2	L
EHS M6x25/30	EMS M6x25/30	EBB 8x30	EA II M6x30	4,8	9,0	17,0
EHS M8x25/30	EMS M8x25/30	EBB 10x30	EA II M8x30	6,4	11,0	18,0
EHS M8x40	EMS M8x40	EBB 10x40	EA II M8x40			28,0
EHS M10x25/30	EMS M10x25/30	EBB 12x30	EA II M10x30	7,9	13,0	18,0
EHS M10x40	EMS M10x40	EBB 12x40	EA II M10x40			24,0
EHS M12x50	EMS M12x50	EBB 15x50	EA II M12x50	10,2	16,5	30,0
EHS M12x50	EMS M12x50	EBB 16x50	EA II M12x50 D			
EHS M16x65	EMS M16x65	EBB 20x65	EA II M16x65	13,5	22	36,0
EHS M20x80	EMS M20x80	EBB 25x80	EA II M20x80	16,4	27	50,0

fischer drop-in anchor EA II

Intended Use
Setting & Drilling tools

Annex B 3

Installation instructions

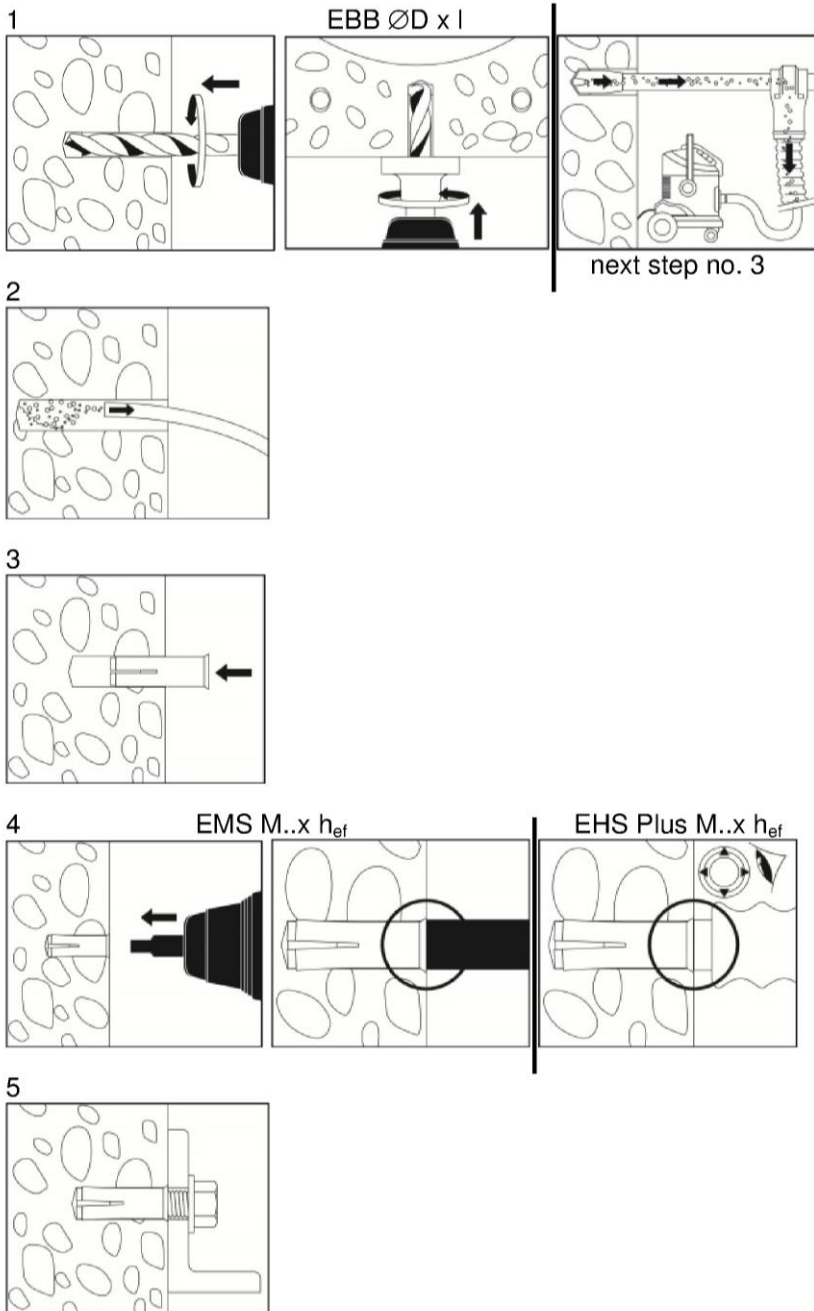

No.	Description
1	Create drill hole with hammer drill or with hollow drill and vacuum cleaner
2	Clean from drill-dust
3	Set anchor till anchor is flush with surface of concrete
4	Expand the sleeve by driving the pin into the sleeve and control the correct setting
5	Fixation of fixture. Maximum installation torque max. T_{inst} must not be crossed

fischer drop-in anchor EA II

Intended Use
Installation instructions

Annex B 4

Table C1: Characteristic values for tension loads due to design method A according to ETAG 001, Annex C or CEN TS 1992-4: 2009

EA II		property class	M6x30 ¹⁾	M8x30 ¹⁾	M8x40	M10x30 ¹⁾	M10x40	M12x50	M12x50 D	M16x65	M20x80
Inastallation safety factor	$\gamma_2 = \gamma_{inst}$	[-]	1,0								
Steel failure											
Characteristic resistance	$N_{Rk,s}$ [kN]	A4-50	10,1	18,3		29,0		42,1		78,3	122,4
Partial safety factor	γ_{Ms}		2,86								
Characteristic resistance	$N_{Rk,s}$ [kN]	A4-70	14,1	19,6		24,9		45,1	59,0	73,8	117,2
Partial safety factor	γ_{Ms}		1,87			1,5			1,87		1,5
Characteristic resistance	$N_{Rk,s}$ [kN]	A4-80	16,1	19,6		24,9		45,1	59,0	73,8	117,2
Partial safety factor	γ_{Ms}		1,6			1,5					
Characteristic resistance	$N_{Rk,s}$ [kN]	steel 4.6	8,0	14,6		23,2		33,7		62,7	97,9
Partial safety factor	γ_{Ms}		2,0								
Characteristic resistance	$N_{Rk,s}$ [kN]	steel 5.6	10,1	18,3		29,0		42,1		78,3	122,4
Partial safety factor	γ_{Ms}		2,0								
Characteristic resistance	$N_{Rk,s}$ [kN]	steel 5.8	10,1	17,2		21,8		39,6	42,1	64,7	102,8
Partial safety factor	γ_{Ms}		1,5								
Characteristic resistance	$N_{Rk,s}$ [kN]	steel 8.8	13,5	17,2		21,8		39,6	53,3	64,7	102,8
Partial safety factor	γ_{Ms}		1,5								
Pull-out failure not decisive											
Concrete cone failure											
Effective anchorage depth	h_{ef}	[mm]	30	40	30	40		50		65	80
Characteristic spacing	$s_{cr,N}$	[mm]	90	120	90	120		150		195	240
Characteristic edge distance	$c_{cr,N}$	[mm]	45	60	45	60		75		97	120
Factor according CEN/TS	k_{ucr}	[-]	10,1								
Splitting failure											
Characteristic spacing	$s_{cr,sp}$	[mm]	210	280	210	320		350		455	560
Characteristic edge distance	$c_{cr,sp}$	[mm]	105	140	105	160		175		227	280

¹⁾ Only for application with statically indeterminate structural components.

fischer drop-in anchor EA II

Performances
Design method A
Characteristic resistance to tension loads

Annex C 1

Table C2: Characteristic values for shear loads due to design method A according to ETAG 001, Annex C or CEN TS 1992-4: 2009

EA II		property class	M6x30 ¹⁾	M8x30 ¹⁾	M8x40	M10x30 ¹⁾	M10x40	M12x50	M12x50 D	M16x65	M20x80
Factor for ductility	k_2	[-]	1,0								
Steel failure without lever arm											
Characteristic resistance	$V_{Rk,s}$	[kN]	A4-50	5,0	9,2	14,5	21,1	39,2	61,2		
Partial safety factor	γ_{Ms}		2,38								
Characteristic resistance	$V_{Rk,s}$	[kN]	A4-70	7,0	9,8	12,4	22,6	29,5	37	59	
Partial safety factor	γ_{Ms}		1,56	1,25				1,56	1,25		
Characteristic resistance	$V_{Rk,s}$	[kN]	A4-80	8,0	9,8	12,4	22,6	30,4	36,9	58,6	
Partial safety factor	γ_{Ms}		1,33	1,25							
Characteristic resistance	$V_{Rk,s}$	[kN]	steel 4.6	4,0	7,3	11,6	16,9	31	49		
Partial safety factor	γ_{Ms}		1,67								
Characteristic resistance	$V_{Rk,s}$	[kN]	steel 5.6	5,0	9,2	14,5	21,1	39	61		
Partial safety factor	γ_{Ms}		1,67								
Characteristic resistance	$V_{Rk,s}$	[kN]	steel 5.8	5,0	8,6	10,9	19,8	21,1	32	51	
Partial safety factor	γ_{Ms}		1,25								
Characteristic resistance	$V_{Rk,s}$	[kN]	steel 8.8	6,8	8,6	10,9	19,8	27	32	51	
Partial safety factor	γ_{Ms}		1,25								
Steel failure with lever arm											
Characteristic resistance	$M^0_{Rk,s}$	[Nm]	A4-50	8	19	37	66	166	324		
Partial safety factor	γ_{Ms}		2,38								
Characteristic resistance	$M^0_{Rk,s}$	[Nm]	A4-70	11	26	52	92	232	454		
Partial safety factor	γ_{Ms}		1,56								
Characteristic resistance	$M^0_{Rk,s}$	[Nm]	A4-80	12	30	60	105	266	519		
Partial safety factor	γ_{Ms}		1,33								
Characteristic resistance	$M^0_{Rk,s}$	[Nm]	Stahl 4.6	6,1	15	30	52	133	259		
Partial safety factor	γ_{Ms}		1,67								
Characteristic resistance	$M^0_{Rk,s}$	[Nm]	Stahl 5.6	7,6	19	37	66	166	324		
Partial safety factor	γ_{Ms}		1,67								
Characteristic resistance	$M^0_{Rk,s}$	[Nm]	Stahl 5.8	7,6	19	37	66	166	324		
Partial safety factor	γ_{Ms}		1,25								
Characteristic resistance	$M^0_{Rk,s}$	[Nm]	Stahl 8.8	12	30	60	105	266	517		
Partial safety factor	γ_{Ms}		1,25								

¹⁾ Only for application with statically indeterminate structural components.

fischer drop-in anchor EA II

Performances
Design method A
Characteristic resistance to shear loads

Annex C 2

Table C3: Characteristic values for shear loads due to design method A according to ETAG 001, Annex C or CEN TS 1992-4: 2009

EA II		M6x30	M8x30	M8x40	M10x30	M10x40	M12x50	M12x50 D	M16x65	M20x80
Concrete pry out failure										
Factor in equation (5.6) of ETAG 001 Annex C, 5.2.3.3	$k = k_3$	1,74	1,88	1,74	1,88	2,0				
Installation safety factor ¹⁾	$\gamma_2 = \gamma_{Inst}$	1,0								
Concrete edge failure										
Effective length of anchor in shear loading	$l_f = h_{ef}$ [mm]	30	40	30	40	50		65	80	
Effective diameter of anchor	$\varnothing d_{nom}$ [mm]	8	10	12		15	16	20	25	

fischer drop-in anchor EA II

Performances
Design method A
Characteristic resistance to shear loads

Annex C 3

Table C4.1: Displacements under tension and shear loads for EA II in galvanised steel

EA II				M6x30	M8x30	M8x40	M10x30	M10x40	M12x50	M12x50 D	M16x65	M20x80
Tension load in C20/25 to C50/60	N	[kN]		4,0	6,1	4,0	6,1	8,5	12,6	17,2		
Displacement	δ_{N_0}	[mm]		0,1								
	δ_{N_∞}	[mm]		0,2								
Shear load in C20/25 to C50/60	V	[kN]		3,9	4,9	6,2	11,3	15,2	18,5	29,4		
Displacement	δ_{V_0}	[mm]		0,95	1,00	1,05	1,10	1,40	1,80			
	δ_{V_∞}	[mm]		1,40	1,50	1,60	1,70	2,10	2,70			

Table C4.2: Displacements under tension and shear loads for EA II in stainless steel

EA II A4				M6x30	M8x30	M8x40	M10x30	M10x40	M12x50	M12x50 D	M16x65	M20x80
Tension load in C20/25 to C50/60	N	[kN]		4,0	6,1	4,0	6,1	8,5	12,6	17,2		
Displacement	δ_{N_0}	[mm]		0,1								
	δ_{N_∞}	[mm]		0,2								
Shear load in C20/25 to C50/60	V	[kN]		3,2	5,6	7,1	12,9	13,5	21,1	33,5		
Displacement	δ_{V_0}	[mm]		0,95	1,00	1,05	1,10	1,40	1,80			
	δ_{V_∞}	[mm]		1,40	1,50	1,60	1,70	2,10	2,70			

fischer drop-in anchor EA II

Performances
Displacements

Annex C 4