



## DECLARATION OF PERFORMANCE



**DoP: 0132**

for fischer Aircrete Anchor FPX-I (Metal expansion fastener for use in autoclaved aerated concrete) – EN

1. Unique identification code of the product-type: **DoP: 0132**
2. Intended use/es: **Post-installed fastening in for use in autoclaved aerated concrete**
3. Manufacturer: **fischerwerke GmbH & Co. KG, Klaus-Fischer-Straße 1, 72178 Waldachtal, Germany**
4. Authorised representative: --
5. System/s of AVCP: **1**
6. European Assessment Document: **EAD 330014-00-0601**

European Technical Assessment: **ETA-12/0456; 2017-11-27**

Technical Assessment Body: **DIBt**

Notified body/ies: **1343 – MPA Darmstadt**

7. Declared performance/s:

### **Mechanical resistance and stability (BWR 1)**

- **Resistance in any load direction without lever arm: See appendix, especially Annex C 1**
- **Resistance in any load direction with lever arm: See appendix, especially Annex C 1**
- **Spacing, edge distance, member thickness: See appendix, especially Annexes B 3 to B 4**
- **Displacements: See appendix, especially Annex C 2**
- **Durability: Durability is ensured if the specifications of intended use according to Annex B are taken into account**

### **Safety in case of fire (BWR 2)**

- **Reaction to fire: Anchorages satisfy requirements for Class A 1**
- **Resistance to fire: NPD**

8. Appropriate Technical Documentation and/or Specific Technical Documentation: ---

The performance of the product identified above is in conformity with the set of declared performance/s. This declaration of performance is issued, in accordance with Regulation (EU) No 305/2011, under the sole responsibility of the manufacturer identified above.

Signed for and on behalf of the manufacturer by:

Andreas Bucher, Dipl.-Ing.

Wolfgang Hengesbach, Dipl.-Ing., Dipl.-Wirtsch.-Ing.

Tumlingen, 2017-12-04

- This DoP has been prepared in different languages. In case there is a dispute on the interpretation the english version shall always prevail.
- The Appendix includes voluntary and complementary information in English language exceeding the (language-neutrally specified) legal requirements.

**Specific Part**

**1 Technical description of the product**

The fischer aircrete anchor FPX-I is a deformation controlled expansion anchor made of galvanised steel. The anchor consists of an internal threaded socket, a cone bolt and an expansion sleeve. The anchor transfers loads into autoclaved aerated concrete via mechanical interlock.

The anchor is set into a predrilled bore hole and anchored with a hexagon installation tool until the installation tool is pushed out of the internal hexagon socket. The fixture is installed with a screw-in part (threaded rods or screw).

The product description is given in Annex A.

**2 Specification of the intended use in accordance with the applicable European assessment Document**

The performances given in Section 3 are only valid if the anchor is used in compliance with the specifications and conditions given in Annex B.

The verifications and assessment methods on which this European Technical Assessment is based lead to the assumption of a working life of the anchor of at least 50 years. The indications given on the working life cannot be interpreted as a guarantee given by the producer, but are to be regarded only as a means for choosing the right products in relation to the expected economically reasonable working life of the works.

**3 Performance of the product and references to the methods used for its assessment**

**3.1 Mechanical resistance and stability (BWR 1)**

<b>Essential characteristic</b>	<b>Performance</b>
Resistance in any load direction without lever arm	See Annex C 1
Resistance in any load direction with lever arm	See Annex C 1
Spacing, edge distance, member thickness	See Annex B 3 and B 4
Displacements	See Annex C 2
Durability	Durability is ensured if the specifications of intended use according to Annex B are taken into account.

**3.2 Safety in case of fire (BWR 2)**

<b>Essential characteristic</b>	<b>Performance</b>
Reaction to fire	The anchor satisfy requirements for Class A1
Resistance to fire	No performance assessed

**4 Assessment and verification of constancy of performance (AVCP) system applied, with reference to its legal base**

In accordance with European Assessment Document EAD No. 330014-00-0601, the applicable European legal act is: [96/582/EC].

The system(s) to be applied is (are): 1

**Product description**

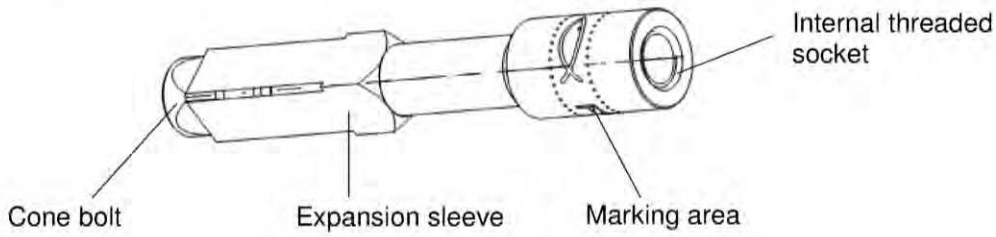

**Product installed**

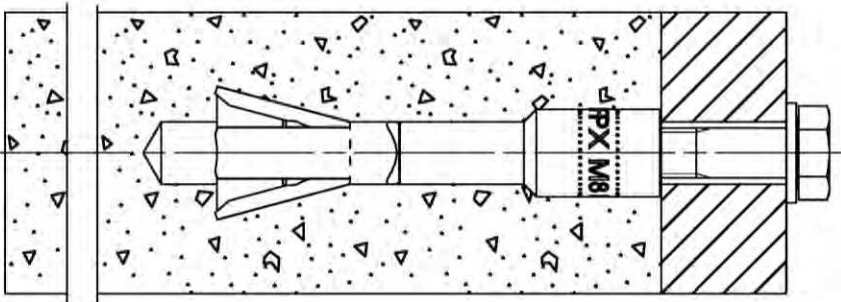

**Product label**

Product label, example:

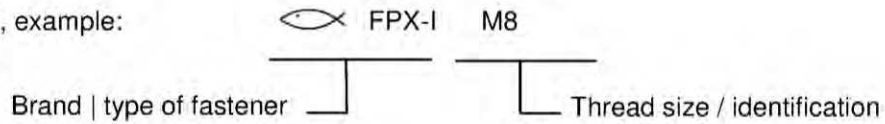

**Product dimensions**

**Table A1.1:** Dimension [mm]

Anchor type	FPX-I			
	M6	M8	M10	M12
Internal thread				
Anchor length	L = 75			
Diameter head internal threaded socket	Ø D = 14			16
Diameter cone bolt	Ø d <sub>c</sub> = 11			

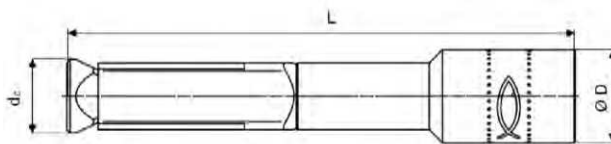

**fischer aircrete anchor FPX-I**

**Product description**  
Description, label and dimension

**Annex A 1**

Specifications of intended use				
fischer aircrete anchor FPX-I	M6	M8	M10	M12
Galvanized steel	✓			
Static and quasi-static loads				
Cracked and uncracked Autoclaved Aerated Concrete (AAC)				

**Base material:**

- Cracked reinforced slabs (uncracked slabs are included) according to EN 12602:2016 of strength class  $f_{AAC} \geq 3,3 \text{ N/mm}^2$  with dry density  $\rho_m \geq 0,50 \text{ kg/dm}^3$  and strength class  $f_{AAC} \geq 4,4 \text{ N/mm}^2$  with dry density  $\rho_m \geq 0,55 \text{ kg/dm}^3$
- Uncracked reinforced slabs according to EN 12602:2016 of strength class  $f_{AAC} \geq 1,6 \text{ N/mm}^2$  with dry density  $\rho_m \geq 0,25 \text{ kg/dm}^3$  to strength class  $f_{AAC} \geq 6,0 \text{ N/mm}^2$  with dry density  $\rho_m \geq 0,65 \text{ kg/dm}^3$
- Masonry units according to EN 771-4: 2003 of strength class  $f_{AAC} \geq 1,6 \text{ N/mm}^2$  with dry density  $\rho_m \geq 0,25 \text{ kg/dm}^3$  to strength class  $f_{AAC} \geq 6,0 \text{ N/mm}^2$  with dry density  $\rho_m \geq 0,65 \text{ kg/dm}^3$
- The mortar strength class of the masonry has to be M 2,5 according to EN 998-2:2010 at minimum

**Use conditions (Environmental conditions):**

- Structures subject to dry internal conditions (FPX-I)

**Design:**

- Anchorages are to be designed under the responsibility of an engineer experienced in anchorages and concrete and masonry work
- Verifiable calculation notes and drawings are to be prepared taking account in the loads to be anchored. The position of the anchor is to be indicated on the design drawings
- Design of fastenings according to TR 054, Design Method B.

**Table B1.1: Material**

Designation	FPX-I
Cone bolt <sup>1)</sup>	Steel strength; $f_{uk} \geq 800 \text{ N/mm}^2$ , $f_{yk} \geq 640 \text{ N/mm}^2$
Expansion sleeve <sup>1)</sup>	$f_{uk} \geq 450 \text{ N/mm}^2$ , $f_{yk} \geq 360 \text{ N/mm}^2$
Internal threaded bolt <sup>1)</sup>	$f_{uk} \geq 450 \text{ N/mm}^2$ , $f_{yk} \geq 360 \text{ N/mm}^2$
Screw-in-parts <sup>1, 2)</sup>	Minimum steel strength class 4.8, DIN EN ISO 898-1

<sup>1)</sup> Galvanized according to EN ISO 4042,  $\geq 5 \mu\text{m}$

<sup>2)</sup> Screw-in parts (screws and threaded rods including nuts and washer) must comply with the specification in Annex C1.

<b>fischer aircrete anchor FPX-I</b>	<b>Annex B 1</b>
<b>Intended use Specifications</b>	

**Table B2.1: Installation parameters**

Size	FPX-I			
	M6	M8	M10	M12
Nominal drill hole diameter	$d_0 = 10$			
Maximum drill bit diameter	$d_{cut} \leq 10,45$			
Depth of drill hole to deepest point	with cleaning <sup>1)</sup>			
	without cleaning $h_1 \geq$ [mm]			
Diameter of clearance hole in the fixture	$d_f \leq$			
Effective embedment depth	$h_{ef} = 70$			
Maximum fastening torque <sup>2)</sup>	$T_{max} = 3$ [Nm]			
Screw-in depth internal thread	$l_{s,min}$ [mm]			
	$l_{s,max} = 15$			

- <sup>1)</sup> For member thickness  $h < 120$  mm the drill hole shall be cleaned and the depth of the drill hole shall be reduced to 80 mm in order to avoid damage on the opposite side of the wall
- <sup>2)</sup> If the anchor cannot retain against the fixture no installation torque may be applied ( $T_{max} = 0$  Nm)

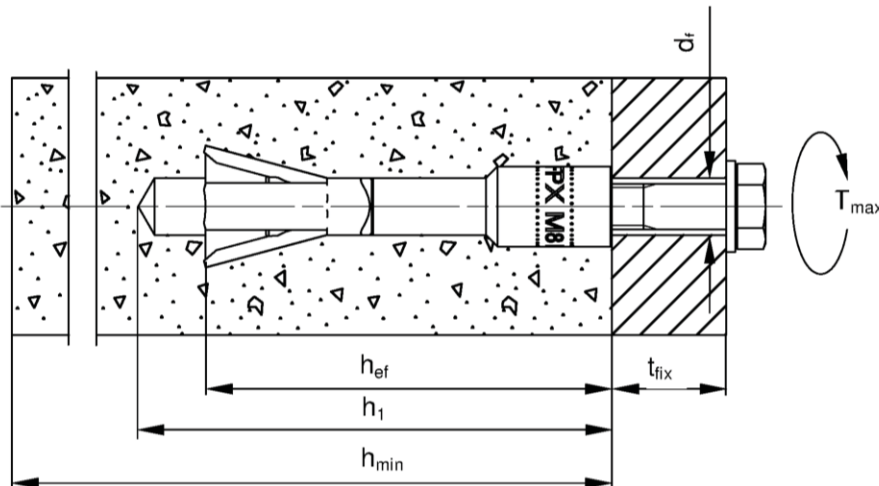

- $h_{ef}$  = Effective embedment depth
- $t_{fix}$  = Thickness of fixture
- $h_1$  = Depth of drill hole to deepest point
- $h_{min}$  = Minimum thickness of AAC member
- $T_{max}$  = Maximum setting torque
- $d_f$  = Diameter of clearance hole in the fixture

**fischer aircrete anchor FPX-I**

**Intended use**  
Installation parameters

**Annex B 2**

**Table B3.1: Minimum member thickness, minimum spacing and edge distance in AAC - slabs**

Size	FPX-I			
	M6	M8	M10	M12
Minimum thickness of AAC - slab	$h_{min}$			
Minimum spacing	$s_{min}$			
Minimum edge distance	$c_1$			
Minimum edge distance, orthogonal to $c_1$	$c_2$			
Minimum spacing between	$a$			

- <sup>1)</sup> For member thickness  $h < 120$  mm the drill dust has to be cleaned out of the hole and the depth of the drill hole has to be reduced to 80 mm in order to avoid damage on the opposite side of the slab
- <sup>2)</sup> Maximum 2 single anchors in the same formation as anchor groups. For 2 single anchors with spacing smaller than 600 mm ( $s_{min} \geq 100$  mm) the same spacing in between and edge distances ( $a$ ;  $c_1$ ) like for the anchor group are valid
- <sup>3)</sup> For exclusive tension loads the spacing and edge distances for groups can be reduced to the spacing and edge distances of single anchors
- <sup>4)</sup> If there is no (free) edge, or the edge distance is  $\geq a$ , the spacing between anchor groups can be reduced to the spacing between single anchors
- <sup>5)</sup> The edge distance of reinforced slabs with a width  $\leq 700$  mm has to be  $\geq 150$  mm

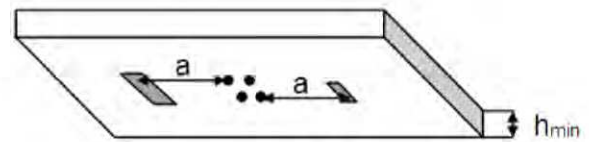
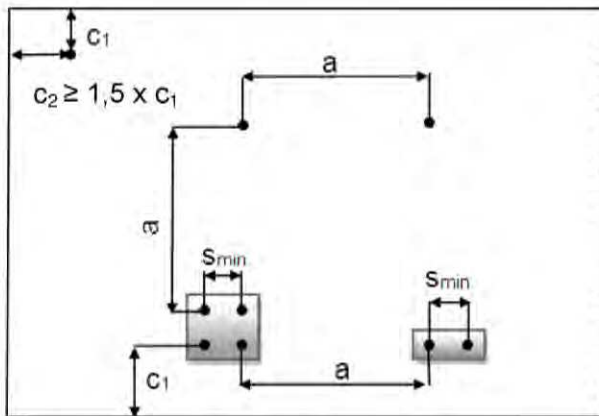

**fischer aircrete anchor FPX-I**

**Intended use**  
Minimum member thickness, minimum spacing and edge distance in AAC slabs

**Annex B 3**



**Table B4.1: Minimum member thickness, minimum spacing and edge distance in AAC - masonry**

Size	FPX-I					
	M6	M8	M10	M12		
Minimum thickness of AAC - masonry	[mm]				with cleaning <sup>1)</sup> $h_{min}$	100
					without cleaning	120
Minimum spacing					$s_{min}$	100
Minimum distance to non-filled joints, single anchor					$c_F$	0 <sup>5)</sup> / 75 <sup>6)</sup> / 125 <sup>7)</sup>
Minimum edge distance					single anchor <sup>2)</sup> $c_1$	125
					anchor groups <sup>3)</sup> $c_1$	250
Minimum edge distance, orthogonal to $c_1$					$c_2$	1,5 x $c_1$
Minimum spacing between					single anchors <sup>2)</sup> $a$	375
					anchors groups <sup>3) 4)</sup> $a$	750

- 1) For member thickness  $h < 120$  mm, the drill hole shall be cleaned and the depth of the drill hole shall be reduced to 80 mm in order to avoid damage on the opposite side of the wall
- 2) Maximum 2 single anchors in the same formation as the anchor groups. For 2 single anchors with spacing smaller than 375 mm ( $s_{min} \geq 100$  mm) the same spacing in between and edge distances ( $a$ ;  $c_1$ ) like for the anchor group are valid
- 3) For exclusive tension loads the spacing and edge distances of anchor groups can be reduced to the spacing and edge distances of single anchors
- 4) If there is no edge, or the edge distance is  $\geq a$ , the spacing between anchor groups can be reduced to the spacing between single anchors
- 5) For joints completely filled with mortar and a joint width  $\leq 12$  mm and a compressive strength according to EN 998-2  $\geq f_{AAC}$  AAC no distances to joints are required
- 6)  $c_F$  for only tension and /or shear loads parallel to the joints which are not filled with mortar and a joint width  $\leq 2$  mm
- 7)  $c_F = c_1$  for shear load or with a part of the load orthogonal to the joint which are not filled with mortar and a joint width  $\geq 0$  mm

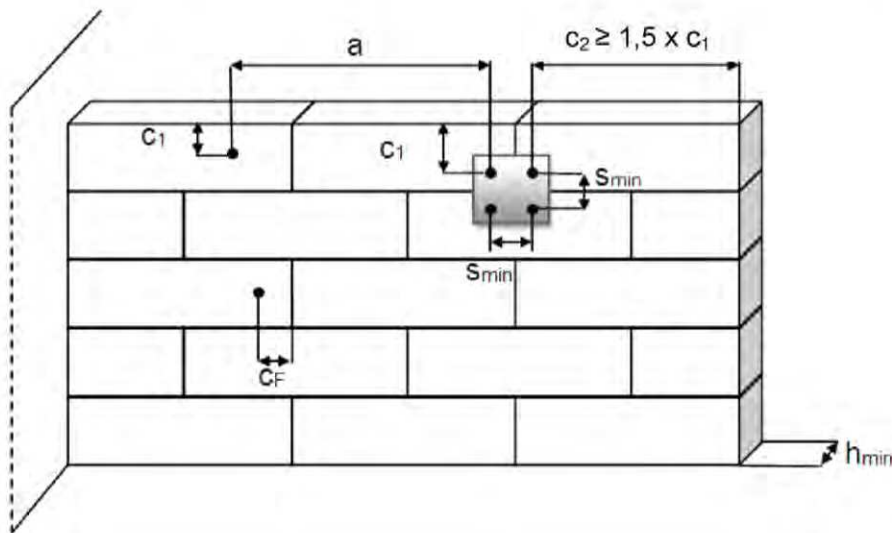

**fischer aircrete anchor FPX-I**



**Intended use**  
Minimum member thickness, minimum spacing and edge distance in AAC masonry

**Annex B 4**

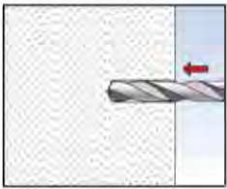
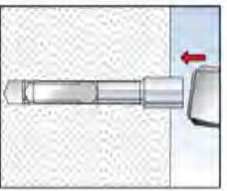
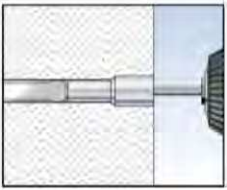

**Installation instruction**

- Anchor installation carried out by appropriately qualified personnel and under the supervision of the person responsible for technical matters of the site
- Use of the anchor only as supplied by the manufacturer without exchanging the components of the anchor
- Checking before placing the anchor to ensure that the strength class of the aircrete in which the anchor is to be placed is in the range given and is not lower than that of the aircrete to which the characteristic loads apply
- Drill hole created perpendicular +/- 5° to AAC surface, positioning without damaging the reinforcement
- In case of aborted hole: New drilling at a minimum distance away of twice the depth of the aborted hole or smaller distance if the aborted hole is filled with non-shrinkage, high strength mortar (pressure strength  $\geq 30 \text{ N/mm}^2$ ) and if under shear or oblique tension load it is not the direction of the load application

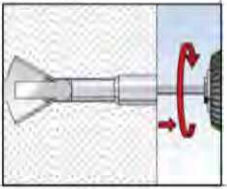
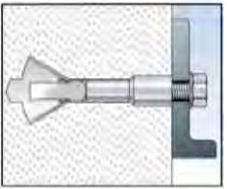
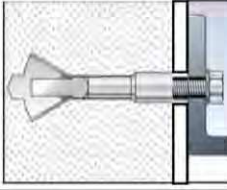
	<p>1: Drill the hole. Other methods like punching, to make the hole, are allowed. When the AAC is covered with a hard layer like tiles, the tile has to be drilled with minimum diameter of the head of the internal threaded bolt <math>\varnothing D</math></p>
	<p>2: Set the fastener until it is flush with the surface of the AAC</p>
	<p>3: Turning the internal thread bolt with the hexagon (approximately 15 turnings are required)</p> <div style="display: flex; justify-content: space-around; align-items: center;"> <div style="text-align: center;">  <p>Setting tool for FPX-I M6</p> </div> <div style="text-align: center;">  <p>Setting tool for FPX-I M8 – M12</p> </div> </div>
	<p>4: By turning the internal thread bolt, the cone is driven into the expansion sleeve. When the optimal expansion is reached, the hexagon is thrown out of the socket. <b>The turning of the internal thread bolt until the hexagon is thrown out of the socket is compulsory</b> if tightening is impossible the anchor cannot be loaded</p>
	<p>5a: Optional tightening the fastener with a torque <math>T_{\max} \leq 3 \text{ Nm}</math>. The anchor could be pulled against the fixture depending on the compressive strength of the AAC.</p>
	<p>5b: If the anchor cannot support against the fixture (with cover layer) no installation torque may be applied (<math>T_{\max} = 0</math>)</p>

**fischer aircrete anchor FPX-I**

**Intended use**  
Installation instructions

**Annex B 5**

<b>Table C1.1: Characteristic resistance for all load directions</b>							
Size	FPX-I						
	M6	M8	M10	M12			
<b>Single anchor in AAC - slabs <sup>1)</sup></b>							
Characteristic resistance in cracked AAC - slabs	$F_{Rk}$ [kN]	$f_{AAC} \geq 3,3, \rho_m \geq 0,50$	1,5				
		$f_{AAC} \geq 4,4, \rho_m \geq 0,55$	2,0				
Characteristic resistance in uncracked AAC - slabs	$F_{Rk}$ [kN]	$f_{AAC} \geq 3,3, \rho_m \geq 0,50$	2,0				
		$f_{AAC} \geq 4,4, \rho_m \geq 0,55$	3,0				
Partial safety factor for AAC - slabs		$\gamma_{MAAC}^{2)}$	1,73				
<b>Single anchor in AAC - masonry <sup>1)</sup></b>							
Characteristic resistance in AAC - masonry <sup>3)</sup>	$F_{Rk}$ [kN]	$f_{AAC} \geq 1,6, \rho_m \geq 0,25$	0,9				
		$f_{AAC} \geq 2,0, \rho_m \geq 0,35$	1,2				
Intermediate values by linear interpolation	$F_{Rk}$ [kN]	$f_{AAC} \geq 4,0, \rho_m \geq 0,50$	2,5				
		$f_{AAC} \geq 6,0, \rho_m \geq 0,65$	4,0				
Partial safety factor for AAC - masonry		$\gamma_{MAAC}^{2)}$	2,0				
<b>Single anchor in AAC - slabs and AAC - masonry <sup>1)</sup></b>							
Characteristic bending resistance with lever arm in combination with screw / threaded rod complying with:	ISO 898-1: 2013	$M_{Rk,s}$ [Nm]	4.8	6	15	30	52
			5.8	8	19	37	65
			6.8	9	23	44	78
			8.8	12	30	60	105
Partial safety factor for AAC - masonry		$\gamma_{Ms}$	1,25				
<b>Anchor groups in cracked and uncracked AAC - slabs and AAC - masonry with n = 2 to n = 4 anchors <sup>3)</sup></b>							
Characteristic resistance for n = 2, n = 4 <sup>4)</sup> $s_{min} \geq 100 \text{ mm}, c_1 \geq 250 \text{ mm}^{5)}$	$F_{Rk,n}$ [kN]		2 x $F_{Rk}$				
Characteristic resistance for n ≥ 3 $s_{min} \geq 140 \text{ mm}, c_{min, anchor group} \geq 700 \text{ mm}^{5)}$			n x $F_{Rk}$				
Characteristic resistance redundancy when the joints are not visible <sup>5)</sup>		$F_{Rk,n,Redundancy}$	0,5 x $F_{Rk,n}$				
Partial safety factor for AAC - slabs		$\gamma_{MAAC}^{2)}$	1,73				
Partial safety factor for AAC - masonry		$\gamma_{MAAC}^{2)}$	2,0				
<sup>1)</sup> Maximum 2 single anchors in the same formation as the anchor groups. For 2 single anchors with spacing smaller than a ( $s_{min} \geq 100 \text{ mm}$ ) the characteristic resistance of the anchor group is decisive <sup>2)</sup> The installation safety factor $\gamma_2 = 1,0$ is included <sup>3)</sup> The evaluation of $N_{Rk,pb}$ according to TR 054, Section 4.2.1.5 is necessary. The smaller value of $N_{Rk,pb}$ and $F_{Rk}$ is decisive <sup>4)</sup> Rectangular arrangement according to drawing Annex B3 and B4 <sup>5)</sup> Only for multiple use according to ETAG 001 Part 6  The characteristic strength class $f_{AAC}$ [N/mm <sup>2</sup> ] and the characteristic dry density $\rho_m$ [kg/dm <sup>3</sup> ] have to comply with EN 771-4:2011+A1:2015 for AAC - masonry and EN 12602:2016 for AAC - slabs							
<b>fischer aircrete anchor FPX-I</b>					<b>Annex C 1</b>		
<b>Performances</b> Characteristic resistance for all load directions							

**Table C2.1:** Displacement under tension loads, shear loads and oblique loads in AAC <sup>1)</sup>

Size		FPX-I			
		M6	M8	M10	M12
Displacement tension load in <b>cracked</b> AAC for all AAC strength classes	$\delta_{N0}$ [mm]	1,0			
	$\delta_{N\infty}$ [mm]	2,0			
Displacement tension load in <b>uncracked</b> AAC for all AAC strength classes	$\delta_{N0}$ [mm]	1,0			
	$\delta_{N\infty}$ [mm]	1,0			
Displacement shear load in <b>cracked and uncracked</b> AAC $f_{AAC} = 1,6 - \rho_m \geq 0,25$ <sup>2)</sup>	$\delta_{V0}$ [mm]	2,5			
	$\delta_{V\infty}$ [mm]	3,7			
Displacement shear load in <b>cracked and uncracked</b> AAC $f_{AAC} \geq 6,0 - \rho_m \geq 0,65$ <sup>2)</sup>	$\delta_{V0}$ [mm]	5,0			
	$\delta_{V\infty}$ [mm]	7,3			

<sup>1)</sup> Displacement at service load level  $F_{Rk} / (\gamma_{MAAC} \times 1,4)$

<sup>2)</sup> Intermediate values by linear interpolation, taking in account the AAC strength

**fischer aircrete anchor FPX-I**

**Performances**

Displacements under tension, shear loads and oblique loads

**Annex C 2**